



Product	Description	Temperature		Page
		°F	°C	
General Applications Tube and Wire	Feature SERV-RITE® wire in a variety of insulation types with a metal sheath over the thermocouple. Wide variety of mounting options for use in general industrial and commercial applications.	Up to 900	Up to 480	26
Mineral Insulated	Fast responding, durable and capable of handling high temperatures with the use of XACTPAK® metal sheathed cable with compacted MgO insulation.	Up to 2200	Up to 1200	45
EXACTSENSE®	Exhaust gas temperature sensor that combines rugged thermocouple technology with signal conditioning into one package. The primary benefits are high accuracy, durability, quick response, long immersion depth and high temperature.	-104 to 2192	-40 to 1200	56
MICROCOIL™	Miniature thermocouple provides surface temperature measurement.	Up to 1292	Up to 700	59
Radio Frequency	Thermocouple designed for use in plasma generation applications.	Up to 932	Up to 500	61
TRUE SURFACE	Flat surface temperature sensor that isolates the thermocouple from ambient airflow.	Up to 400	Up to 200	63
Multipoints	Accurately measures temperatures at various locations. Constructed with a variety of protection tubes with XACTPAK mineral insulated metal sheathed cable.	Up to 2200	Up to 1200	65





General Information

Calibration Types

Thermocouples are classified by calibration type because they have varying electromotive force (EMF) versus temperature curves. Some generate considerably more voltage at lower temperatures, while others do not begin to develop a significant voltage until subjected to high temperatures. Also, calibration types are designed to deliver as close to a straight line voltage curve inside their temperature application range as possible. This makes it easier for an instrument or temperature controller to correctly correlate the received voltage to a particular temperature.

Additionally, thermocouple calibration types have different levels of compatibility with different atmospheres. Chemical reaction between certain thermocouple alloys and the application atmosphere could cause metallurgy degradation, making another calibration type more suitable for sensor life and accuracy requirements.

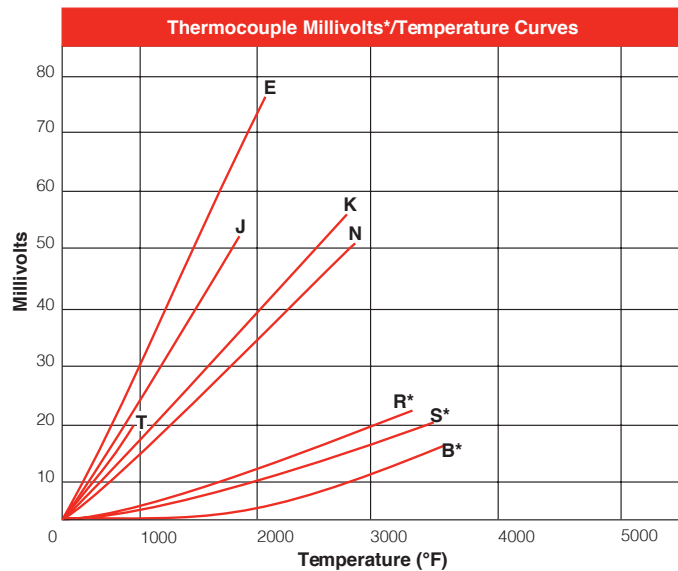

*Millivolt values shown for R and S calibrations pertain to thermocouple calibrations only. RX and SX constructions described in this catalog section are intended for use as **extension wire only** and will not exhibit the millivolt outputs shown.

Thermocouple Types

Calibration types have been established by the American Society for Testing and Materials (ASTM) according to their temperature versus EMF characteristics in accordance with ITS-90, in standard or special tolerances.

Additionally, there are non-ASTM calibration types. These thermocouples are made from tungsten and tungsten-rhenium alloys. Generally used for measuring higher temperatures, they are a more economical alternative to the platinum and platinum alloy based noble metal thermocouples, but limited to use in inert and non-oxidizing atmospheres.

Thermocouple Type	Useful/General Application Range
B	1600-3100°F (870-1700°C)
E*	200-1650°F (95-900°C)
J	200-1400°F (95-760°C)
K*	200-2300°F (95-1260°C)
N	200-2300°F (95-1260°C)
R	32-2700°F (0-1480°C)
S	32-2700°F (0-1480°C)
T*	32-660°F (0-350°C)

*Also suitable for cryogenic applications from -328 to 32°F (-200 to 0°C)



General Information

Calibration Types

Type E

The Type E thermocouple is suitable for use at temperatures up to 1650°F (900°C) in a vacuum, inert, mildly oxidizing or reducing atmosphere. At cryogenic temperatures, the thermocouple is not subject to corrosion. This thermocouple has the highest EMF output per degree of all the commonly used thermocouples.

Type J

Type J is the second most common calibration type and is a good choice for general purpose applications where moisture is not present.

The Type J thermocouple may be used, exposed or unexposed, where there is a deficiency of free oxygen. For cleanliness and longer life, a protection tube is recommended. Since iron (JP) wire will oxidize rapidly at temperatures over 1000°F (540°C), it is recommended that larger gauge wires be used to compensate. Maximum recommended operating temperature is 1400°F (760°C).

Type K

Type K thermocouples usually work in most applications as they are nickel based and exhibit good corrosion resistance. It is the most common sensor calibration type providing the widest operating temperature range.

Due to its reliability and accuracy the Type K thermocouple is used extensively at temperatures up to 2300°F (1260°C). This type of thermocouple should be protected with a suitable metal or ceramic protection tube, especially in reducing atmospheres. In oxidizing atmospheres, such as electric furnaces, tube protection is not always necessary when other conditions are suitable; however, it is recommended for cleanliness and general mechanical protection. Type K will generally outlast Type J because the JP wire rapidly oxidizes, especially at higher temperatures.

Type N

This nickel-based thermocouple alloy is used primarily at high temperatures up to 2300°F (1260°C). While not a direct replacement for Type K, Type N provides better resistance to oxidation at high temperatures and longer life in applications where sulfur is present. It also outperforms Type K in K's aging range.

Type T

This thermocouple can be used in either oxidizing or reducing atmospheres though for longer life a protecting tube is recommended. Because of its stability at lower temperatures, this is a superior thermocouple for a wide variety of applications in low and cryogenic temperatures. Its recommended operating range is -330° to 660°F (-200° to 350°C), but it can be used up to -452°F (-269°C) (boiling helium).



General Information

Maximum Temperatures

The diameter of the sensor wires determines the upper most operating temperature. The larger the diameter, the higher the temperature rating.

Choose alloy 600 over 304 stainless steel (SS) or 316 SS when higher temperatures are expected.

The environment is also a critical factor when determining the best material to use. Consult the manual on **The Use of Thermocouples in Temperature Measurement**, published by ASTM for further details.

Recommended Upper Temperature Limit for Protected Thermocouple Wire

Thermocouple Type	No. 8 Gauge °F (°C)	No. 14 Gauge °F (°C)	No. 20 Gauge °F (°C)	No. 24 Gauge °F (°C)	No. 28 Gauge °F (°C)
E	1600 (870)	1200 (650)	1000 (540)	800 (430)	800 (430)
J	1400 (760)	1100 (590)	900 (480)	700 (370)	700 (370)
K and N	2300 (1260)	2000 (980)	1800 (980)	1600 (870)	1600 (870)
R and S				2700 (1480)	
T		500 (260)	500 (260)	400 (200)	400 (200)

This table gives the recommended upper temperature limits for the various thermocouples and wire sizes. These limits apply to protected thermocouples in conventional closed-end protecting tubes. They do not apply to sheathed thermocouples with compacted mineral oxide insulation.

The temperature limits shown here are intended only as a guide and should not be taken as absolute values nor as guarantees of satisfactory life or performance. These types and sizes are sometimes used at temperatures above the given limits, but usually at the expense of stability, life or both. In other instances, it may be necessary to reduce the above limits to achieve adequate service.

Mineral Insulated Sensors by Diameter and Sheath

Sheath Diameter in.	Calibration	Sheath Material	Maximum Recommended Operating Temperature	
			°F	(°C)
0.032	K	304 SS/Alloy 600	1600	(871)
0.032	J	304 SS	1500	(816)
0.040	K	304 SS/316 SS/Alloy 600	1600	(871)
0.040	J	304 SS	1500	(816)
0.040	T	304 SS	662	(350)
0.040	E	304 SS	1600	(871)
0.063	K or N	Alloy 600	2000	(1093)
0.063	S	Alloy 600	2000	(1093)
0.063	J	304 SS/316 SS	1500	(816)
0.063	E	304 SS	1600	(871)
0.063	K	304 SS/316 SS	1600	(871)
0.063	K	Hastelloy® X	2200	(1204)
0.125	K or N	Alloy 600	2150	(1177)
0.125	T	304 SS/316 SS/Alloy 600	662	(350)
0.125	E	Alloy 600	1600	(871)
0.125	S	Alloy 600	2150	(1177)
0.125	J	304 SS/316 SS	1500	(816)
0.125	K	304 SS	1600	(871)
0.250	K or N	Alloy 600	2150	(1177)
0.250	J	304 SS/310 SS/316 SS	1500	(816)
0.250	K	304 SS	1600	(871)
0.250	T	304 SS	662	(350)
0.250	E	304 SS/316 SS	1600	(871)
0.250	K	310 SS	2000	(1093)
0.250	K	316 SS	1600	(871)
0.250	T	316 SS	662	(350)
0.250	K	446 SS	2100	(1149)



General Information

Junction Types

Generally, the **grounded junction** offers the best compromise between performance and reliability. It is the best choice for general purpose measurements.

Select an **ungrounded junction** if the lead wire will be shielded and attached to the sheath. Also, select the ungrounded junction to avoid ground loops between instruments, power supplies and the sensor.

Listed below are junction styles offered by Watlow.

Exposed Junction



Thermocouple wires are butt welded, insulated and sealed against liquid or gas penetration. This junction style provides the fastest possible response time but leaves the thermocouple wires unprotected against corrosive or mechanical damage.

Grounded Junction

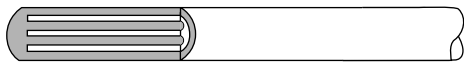

The sheath and conductors are welded together, forming a completely sealed, integral junction. The grounded junction is recommended in the presence of liquids, moisture, gas or high pressure. The wire is protected from corrosive or erosive conditions. Response time with this style approaches that of the exposed junction.

Ungrounded Junction



The thermocouple junction is fully insulated from the welded sheath end. The ungrounded junction is excellent for applications where stray EMFs would affect the reading and for frequent or rapid temperature cycling. Response time is longer than with the grounded junction.

Ungrounded Dual Isolated Junction



Two separate thermocouples are encased in a single sheath. The isolation prevents ground loop errors if wired to separate instruments. Only available as ungrounded junctions.



General Information

Response Time

The smaller the diameter, the faster the thermocouple responds. Grounding the junction also improves response time by approximately 50 percent based on the sensor achieving 63.2 percent of the final reading or to the first time constant. It takes approximately five time constants to obtain steady state readings.

Temperature accuracy of the surrounding medium depends on the capability of the sensor to conduct heat from its outer sheath to the element wire.

Several factors come into play. Most commonly noted is “time constant” (thermal response time). Time constant, or thermal response time, is an expression of how quickly a sensor responds to temperature changes. As expressed here, time response is defined as the length of time it takes a sensor to reach 63.2 percent of a step temperature change (see graph to the right).

Response is a function of the mass of the sensor and its efficiency in transferring heat from its outer surfaces to the wire sensing element. A rapid time response is essential for accuracy in a system with sharp temperature changes. Time response varies with the probe’s physical size and design.

Response times indicated represent standard industrial probes.

**Time Constant
(Thermal Response Time)**

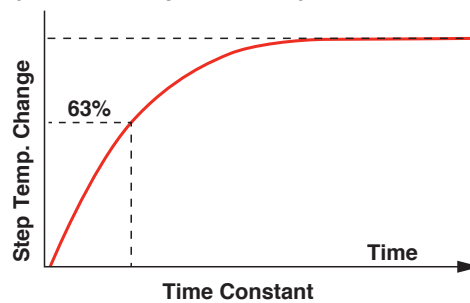

Mineral Insulated Thermocouple Time Response

Sheath Diameter	Average Response Time Still Water (seconds)*	
	Grounded Junction	Ungrounded Junction
0.010 in.	<0.02	<0.02
0.020 in.	<0.02	0.03
0.032 in.	0.02	0.07
0.040 in.	0.04	0.13
0.063 in.	0.22	0.40
0.090 in.	0.33	0.68
0.125 in.	0.50	1.10
0.188 in.	1.00	2.30
0.250 in.	2.20	4.10
0.313 in.	5.00	7.00
0.375 in.	8.00	11.00
0.500 in.	15.00	20.00
0.5 mm	<0.02	0.03
1.0 mm	0.04	0.13
1.5 mm	<0.15	0.35
2.0 mm	0.25	0.55
3.0 mm	0.40	0.90
4.5 mm	0.95	2.00
6.0 mm	2.00	3.50
8.0 mm	5.00	7.00

*Readings are to 63 percent of measured temperatures.



General Information

Thermocouple Resistance

Although resistance cannot confirm that the alloy meets the correct thermoelectric specifications, it checks for other undesirable characteristics such as opens, poor welds or wire corrosion. Always measure thermocouple resistance outside of the application to ensure that EMF output does not conflict with the resistance meter.

Ohms per Double Feet

Long lead wire runs or use of analog-based instrumentation make conductor resistance an important factor when selecting the wire gauge best suited for an application. The table below lists nominal ohms per double feet for thermocouple and thermocouple extension wire. Ohms per double feet are the total resistance, in ohms, for both conductors, per foot.

Nominal Resistance for Thermocouple Alloys in Ohms per Double Feet at 20°C

AUG Gauge	Calibration Type						
	Diameter in. (mm)	E	J	K	N	RX, SX	T
2	0.258 (6.543)	0.011	0.006	0.009	0.012		
4	0.204 (5.189)	0.017	0.009	0.014	0.019		
6	0.162 (4.115)	0.028	0.014	0.023	0.030		
8	0.129 (3.264)	0.044	0.023	0.036	0.048		
10	0.102 (2.588)	0.070	0.036	0.058	0.077		
12	0.081 (2.053)	0.111	0.057	0.092	0.123	0.006	0.048
14	0.064 (1.630)	0.177	0.091	0.147	0.195	0.010	0.076
16	0.051 (1.290)	0.281	0.145	0.233	0.310	0.016	0.120
18	0.040 (1.020)	0.453	0.234	0.376	0.500	0.025	0.194
20	0.032 (0.813)	0.709	0.367	0.589	0.783	0.040	0.304
22	0.025 (0.645)	1.129	0.584	0.937	1.245	0.063	0.483
24	0.020 (0.508)	1.795	0.928	1.490	1.980	0.100	0.768
26	0.016 (0.406)	2.853	1.476	2.369	3.148	0.159	1.221
28	0.013 (0.320)	4.537	2.347	3.767	5.006	0.253	1.942
30	0.010 (0.254)	7.214	3.731	5.990	7.960	0.402	3.088
32	0.008 (0.203)	11.470	5.933	9.524	12.656	0.639	4.910
34	0.006 (0.152)	18.239	9.434	15.145	20.126	1.016	7.808
36	0.005 (0.127)	29.000	15.000	24.080	32.000	1.615	12.415
14 Stranded	0.076 (1.930)	0.161	0.083	0.134	0.178	0.009	0.069
16 Stranded	0.060 (1.520)	0.408	0.133	0.213	0.283	0.014	0.110
18 Stranded	0.048 (1.220)	0.256	0.211	0.338	0.450	0.023	0.174
20 Stranded	0.038 (0.965)	0.648	0.335	0.538	0.715	0.036	0.277
22 Stranded	0.030 (0.762)	1.031	0.533	0.856	1.137	0.057	0.441
24 Stranded	0.024 (0.610)	1.639	0.848	1.361	1.808	0.091	0.701

Note: RX and SX indicate compensating thermocouple materials.



General Information

Thermocouple Resistance

Conductor Sizes

Wire Size	Solid		Stranded		Number of Strands	Strand Gauge
	Diameter in.	Diameter (mm)	Diameter in.	Diameter (mm)		
14	0.064	(1.630)	0.076	(1.930)	7	22
16	0.051	(1.290)	0.060	(1.520)	7	24
18	0.040	(1.020)	0.048	(1.220)	7	26
20	0.032	(0.813)	0.038	(0.965)	7	28
22	0.025	(0.635)	0.030	(0.762)	7	30
24	0.020	(0.508)	0.024	(0.610)	7	32
26	0.016	(0.406)				
28	0.013	(0.330)				
30	0.010	(0.254)				
32	0.008	(0.203)				
34	0.006	(0.152)				
36	0.005	(0.127)				



Thermocouples

General Information

How Do I Install a Sensor with Spring Loaded Bayonet Cap?

The bayonet adapter is used in conjunction with the spring loaded bayonet cap attached to the sensor sheath. The part to be measured is drilled and tapped for the installation of the bayonet adapter. After placing the sensor

through the adapter, the spring is compressed and locked with the bayonet cap. This allows the sensing zone to be pushed tightly against the surface for increased accuracy and faster response time.

"B" Dimension	Adapter Length				
	0.875	1	1.5	2	2.5
2.0	0.500	0.375	2	—	—
2.5	0.875	0.750	0.375	—	—
3.0	1.375	1.250	0.750	0.375	—
3.5	1.875	1.750	1.250	0.750	0.375
4.0	2.375	2.250	1.750	1.250	0.750
4.5	2.875	2.750	0.250	1.750	1.250
5.0	3.375	3.250	2.750	2.250	1.750
5.5	3.875	3.750	3.250	2.750	2.250
6.0	4.375	4.250	3.750	3.250	2.750
6.5	4.875	4.750	4.250	3.750	3.250
7.0	5.375	5.250	4.750	4.250	3.750
7.5	5.875	5.750	5.250	4.750	4.250
8.0	6.375	6.250	5.750	5.250	4.750
8.5	6.875	6.750	6.250	5.750	5.250
9.0	7.375	7.250	6.750	6.250	5.750
9.5	7.875	7.750	7.250	6.750	6.250
10.0	8.375	8.250	7.750	7.250	6.750
10.5	8.875	8.750	8.250	7.750	7.250
11.0	9.375	9.250	8.750	8.250	7.750
11.5	9.875	9.750	9.250	8.750	8.250
12.1	10.375	10.250	9.750	9.250	8.750

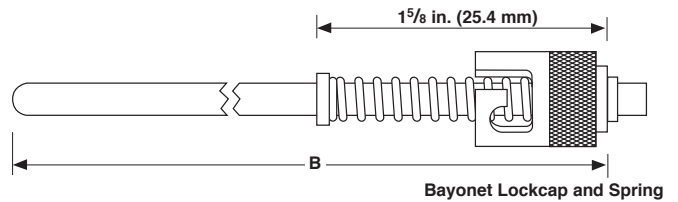
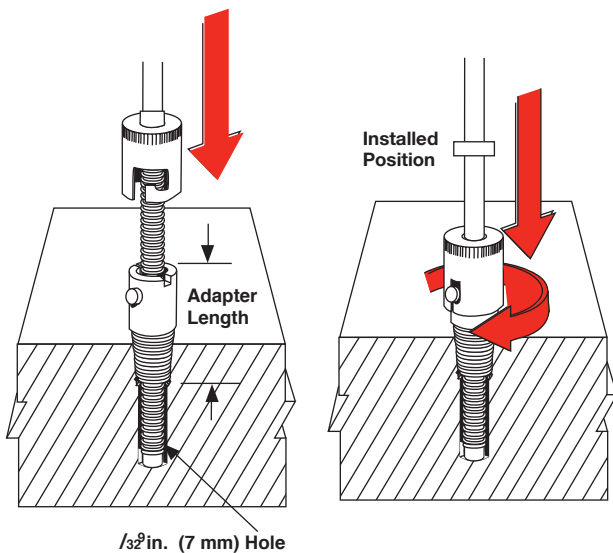

General Applications Tube and Wire

Watlow® is a world class supplier of temperature measurement products, with more than 90 years of manufacturing, research and design expertise.

Companies engaged in critical process control of food and metals rely on Watlow thermocouples. Watlow designs and manufactures sensors to meet customers' industrial and commercial equipment needs.

Watlow has developed an extensive line of thermocouples to meet a broad range of sensing needs.

Performance Capabilities

- Fiberglass insulated thermocouples can reach temperatures up to 900°F (480°C) for continuous operation

Features and Benefits

Standard products including:

- 32 standard sheath lengths
- Lead lengths from six to 360 inches
- Stainless steel braid or hose protection
- J, K, T and E calibrations
- Grounded, ungrounded and exposed junctions
- Flat and drill point
- Epoxy sealed cold ends
- Adjustable depths
- Flexible extensions
- Washers, nozzles and clamp bands
- PFA coated and stainless steel sheaths
- Straight, 45° bend or 90° bend
- Locking bayonet caps in standard
- 300 series stainless tubing

Typical Applications

- Food processing equipment
- De-icing
- Plating baths
- Industrial processing
- Medical equipment
- Pipe tracing control
- Industrial heat treating
- Packaging equipment
- Liquid temperature measurement
- Refrigerator temperature control
- Oven temperature control

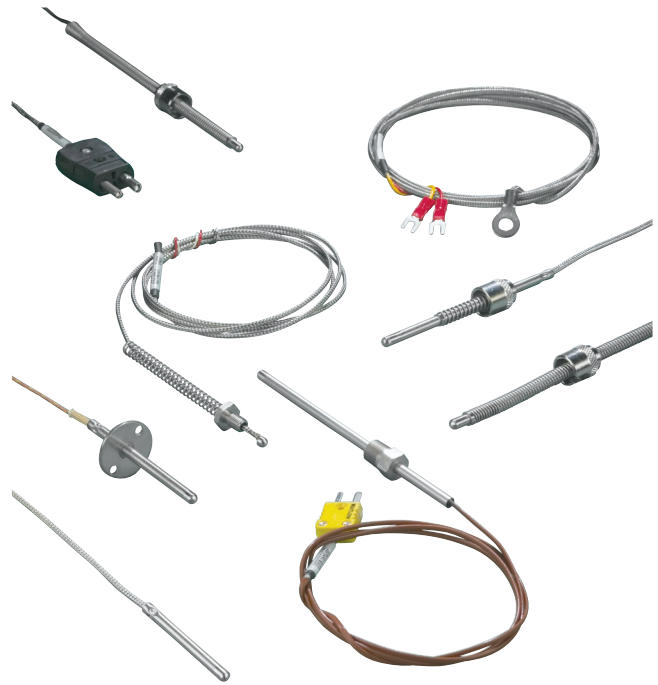

Construction and Tolerances

Thermocouples feature flexible SERV-RITE® wire insulated with woven fiberglass or high temperature engineered resins. For added protection against abrasion, products can be provided with stainless steel wire braid and flexible armor. ASTM E230 color-coding identifies standard catalog thermocouple types.

The addition of a metal sheath over the thermocouple provides rigidity for accurate placement and added protection of the sensing junction. Mounting options include springs, ring terminals, specialized bolts, pipe style clamps and shims.



Thermocouples



General Applications Tube and Wire

Bends

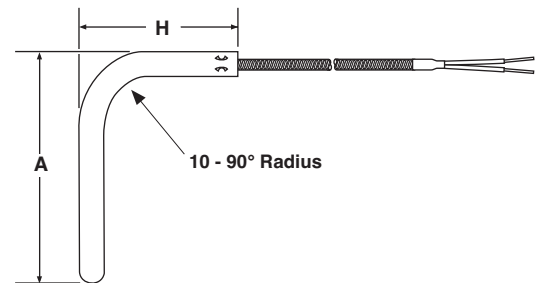
Diameter in.	Standard Bend Radius in.	Minimum "A" Dimension in.	Minimum "H" Dimension in.
0.125	3/8	1	2
0.188	3/8	1	2
0.250	1/2	2	2
0.375	3/4	3	2

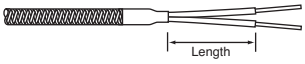
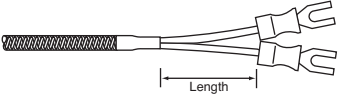
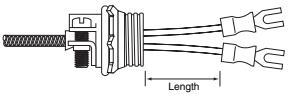
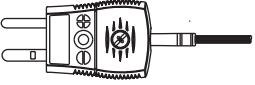
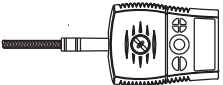
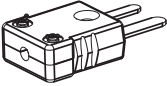

Lead Terminations

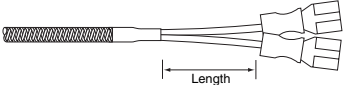
Terminations	Code	Length
 <p>Split Leads</p>	A	2 1/2
 <p>#6 Spade Lugs</p>	B	2 1/2
 <p>#6 Spade Lugs and BX Connector</p>	C	2 1/2
 <p>Standard Male Plug</p>	D	—
 <p>Standard Female Jack</p>	E	—
 <p>Miniature Male Plug</p>	F	—
 <p>Miniature Female Jack</p>	G	—
 <p>1/4 inch Push-on Connectors</p>	H	2 1/2



General Applications Tube and Wire

Adjustable Spring Styles 10 and 11

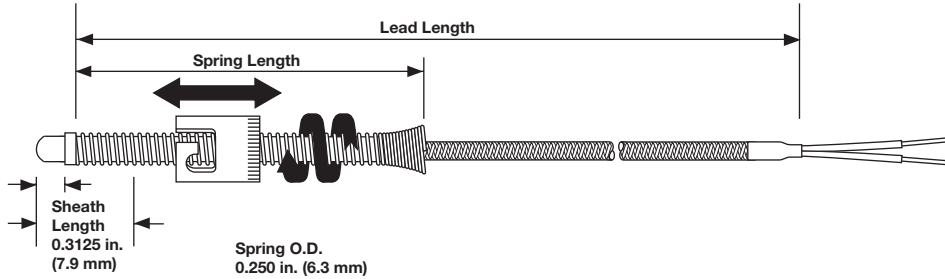

Adjustable spring style thermocouples bend to any angle to fit a wide range of hole depths, eliminating the need to stock numerous styles.

Ordering Information

Part Number

1 2	3	4	5	6	7	8 9 10	11
Const. Style	Sheath Diameter	Calibration	Lead Protection	Junction	Sheath Length	Lead Length	Term./Options
	D				B		

1 2	Construction Style
10 =	7/16 in. I.D. single slot (standard cap) - 6 in. spring
11 =	7/16 in. I.D. single slot (standard cap) - 12 in. spring

3	Sheath Diameter (in.) 300 Series SS
D =	3/16 in.

4	Calibration
J =	Type J
K =	Type K
T =	Type T
E =	Type E

5	Lead Protection
F =	Fiberglass (24 gauge stranded)
S =	Fiberglass with stainless steel overbraid (24 gauge stranded)
P =	Fiberglass (20 gauge stranded)
B =	Fiberglass with stainless steel overbraid (20 gauge stranded)
T =	PFA (24 gauge stranded)
U =	PFA with stainless steel overbraid (24 gauge stranded)
V =	PFA (20 gauge stranded)
W =	PFA with stainless steel overbraid (20 gauge stranded)

6	Junction
F =	Grounded, flat tip
G =	Grounded, round tip
D =	Grounded, drill point
R =	Ungrounded, flat tip
U =	Ungrounded, round tip
P =	Ungrounded, drill point

7	Sheath Length (in.)
B =	1 in. (25 mm)

8 9 10	Lead Length (in.)
Available lengths: 006 to 360 in., over 360 in. contact factory	

11	Termination/Options
A =	Standard, 2 1/2 in. split leads
B =	2 1/2 in. split leads with #6 spade lugs
C =	2 1/2 in. split leads with #6 spade lugs and BX connector
D =	Standard male plug, quick disconnect
E =	Standard female jack, quick disconnect
F =	Miniature male plug, quick disconnect
G =	Miniature female jack, quick disconnect
H =	1/4 in. push-on connector



General Applications Tube and Wire

Adjustable Armor Style 12

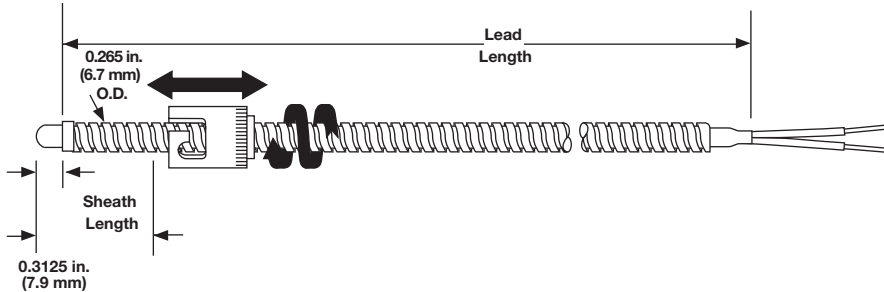

Adjustable armor thermocouples bend to any angle to fit a wide range of hole depths, eliminating the need to stock numerous styles. A stainless steel hose offers additional lead protection in demanding applications.

Ordering Information

Part Number

1 2	3	4	5	6	7	8 9 10	11
Const. Style	Sheath Diameter	Calibration	Lead Protection	Junction	Sheath Length	Lead Length	Term./Options
12	D				B		

1 2	Construction Style
12 =	Adjustable armor thermocouple, 7/16 in. I.D. single slot (standard cap)

3	Sheath Diameter (in.) 300 Series SS
D =	3/16 in.

4	Calibration
J =	Type J
K =	Type K
T =	Type T
E =	Type E

5	Lead Protection
H =	Fiberglass with stainless steel flex hose (24 gauge stranded)
K =	PFA with stainless steel hose (24 gauge stranded)

6	Junction
F =	Grounded, flat tip
G =	Grounded, round tip
D =	Grounded, drill point
U =	Ungrounded, round tip
P =	Ungrounded, drill point
R =	Ungrounded, flat tip

7	Sheath Length (in.)
B =	1 in.

8 9 10	Lead Length (in.)
Available lengths: 006 to 360 in., over 360 in. contact factory	

11	Termination/Options
A =	Standard, 2 1/2 in. split leads
B =	2 1/2 in. split leads with #6 spade lugs
C =	2 1/2 in. split leads with #6 spade lugs and BX connector
D =	Standard male plug, quick disconnect
E =	Standard female jack, quick disconnect
F =	Miniature male plug, quick disconnect
G =	Miniature female jack, quick disconnect
H =	1/4 in. push-on connector



General Applications Tube and Wire

Rigid Sheath
Styles 20, 21 and 22
1/8 and 3/16 inch Diameter



The rigid sheath provides protection and accurate placement through bulkheads or platens. Use with a compression fitting for water tight immersion application.

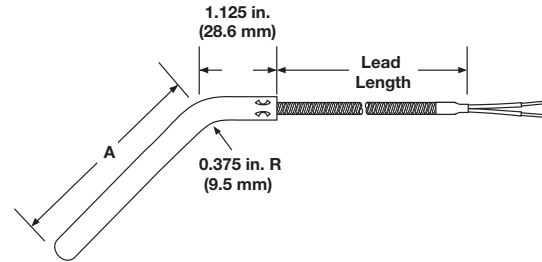
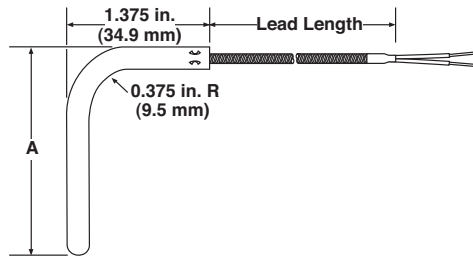
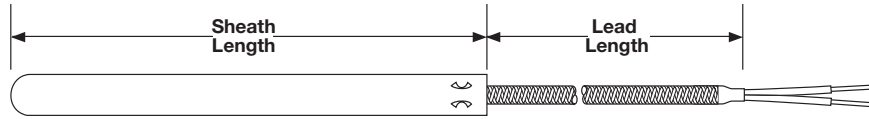

Ordering Information

Part Number

① ②	③	④	⑤	⑥	⑦	⑧ ⑨ ⑩	⑪
Const. Style	Sheath Diameter	Calibration	Lead Protection	Junction	Sheath Length	Lead Length	Term./Options

① ②	Construction Style
20 =	Plain sheath, straight
21 =	Plain sheath, 45° bend
22 =	Plain sheath, 90° bend

③	Sheath Diameter (in.) 300 Series SS
C =	1/8 in.
D =	3/16 in.
T =	3/16 in. epoxy sealed 300°F (149°C)

④	Calibration
J =	Type J
K =	Type K
T =	Type T
E =	Type E

⑤	Lead Protection
F =	Fiberglass (24 gauge stranded)
S =	Fiberglass with stainless steel overbraid (24 gauge stranded)
H =	Fiberglass with stainless steel hose (24 gauge stranded)
P* =	Fiberglass (20 gauge stranded)
B* =	Fiberglass with stainless steel overbraid (20 gauge stranded)
T =	PFA (24 gauge stranded)
U =	PFA with stainless steel overbraid (24 gauge stranded)
K =	PFA with stainless steel hose (24 gauge stranded)
V* =	PFA (20 gauge stranded)
W* =	PFA with stainless steel overbraid (20 gauge stranded)

* Not available with 1/8 in. diameter sheath.

⑥	Junction
F =	Grounded, flat tip
G =	Grounded, round tip
D =	Grounded, drill point
R =	Ungrounded, flat tip
U =	Ungrounded, round tip
P =	Ungrounded, drill point
E =	Exposed

⑦	Sheath Length (in.)				
A* =	1/2 in.	J =	4 1/2 in.	S =	8 1/2 in.
B* =	1 in.	K =	5 in.	T =	9 in.
C =	1 1/2 in.	L =	5 1/2 in.	U =	9 1/2 in.
D =	2 in.	M =	6 in.	W =	10 in.
E =	2 1/2 in.	N =	6 1/2 in.	Y =	11 in.
F =	3 in.	P =	7 in.	Z =	12 in.
G =	3 1/2 in.	Q =	7 1/2 in.		
H =	4 in.	R =	8 in.		

* Not available in construction style 21 and 22.

⑧ ⑨ ⑩	Lead Length (in.)
Available lengths: 006 to 360 in., over 360 in. contact factory	

⑪	Termination/Options
A =	Standard, 2 1/2 in. split leads
B =	2 1/2 in. split leads with #6 spade lugs
C =	2 1/2 in. split leads with #6 spade lugs and BX connector
D =	Standard male plug, quick disconnect
E =	Standard female jack, quick disconnect
F =	Miniature male plug, quick disconnect
G =	Miniature female jack, quick disconnect
H =	1/4 in. push-on connector



Thermocouples

General Applications Tube and Wire

Rigid Sheath with Threaded Fitting

Styles 23 and 24

1/8 and 3/16 inch Diameter

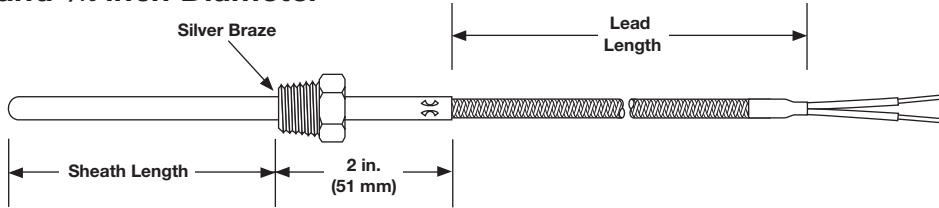

Rigid sheath with threaded fitting provides accurate placement in process applications.

Ordering Information

Part Number

1 2	3	4	5	6	7	8 9 10	11
Const. Style	Sheath Diameter	Calibration	Lead Protection	Junction	Sheath Length	Lead Length	Term./Options

1 2	Construction Style
23 =	Straight sheath with 1/8 in. National Pipe Thread (NPT) SS fitting
24 =	Straight sheath with 1/2 in. NPT SS fitting

3	Sheath Diameter (in.) 300 Series SS
C =	1/8 in.
D =	3/16 in.
T =	3/16 in. epoxy sealed 300°F (149°C)

4	Calibration
J =	Type J
K =	Type K
T =	Type T
E =	Type E

5	Lead Protection
F =	Fiberglass (24 gauge stranded)
S =	Fiberglass with stainless steel overbraid (24 gauge stranded)
H =	Fiberglass with stainless steel hose (24 gauge stranded)
P* =	Fiberglass (20 gauge stranded)
B* =	Fiberglass with stainless steel overbraid (20 gauge stranded)
T =	PFA (24 gauge stranded)
U =	PFA with stainless steel overbraid (24 gauge stranded)
K =	PFA with stainless steel hose (24 gauge stranded)
V* =	PFA (20 gauge stranded)
W* =	PFA with stainless steel overbraid (20 gauge stranded)
* Not available with 1/8 in. diameter sheath.	

6	Junction
F =	Grounded, flat tip
G =	Grounded, round tip
D =	Grounded, drill point
R =	Ungrounded, flat tip
U =	Ungrounded, round tip
P =	Ungrounded, drill point
E =	Exposed

7	Sheath Length (in.)				
A =	1/2 in.	J =	4 1/2 in.	S =	8 1/2 in.
B =	1 in.	K =	5 in.	T =	9 in.
C =	1 1/2 in.	L =	5 1/2 in.	U =	9 1/2 in.
D =	2 in.	M =	6 in.	W =	10 in.
E =	2 1/2 in.	N =	6 1/2 in.	Y =	11 in.
F =	3 in.	P =	7 in.	Z =	12 in.
G =	3 1/2 in.	Q =	7 1/2 in.		
H =	4 in.	R =	8 in.		

8 9 10	Lead Length (in.)
Available lengths: 006 to 360 in., over 360 in. contact factory	

11	Termination/Options
A =	Standard, 2 1/2 in. split leads
B =	2 1/2 in. split leads with #6 spade lugs
C =	2 1/2 in. split leads with #6 spade lugs and BX connector
D =	Standard male plug, quick disconnect
E =	Standard female jack, quick disconnect
F =	Miniature male plug, quick disconnect
G =	Miniature female jack, quick disconnect
H =	1/4 in. push-on connector

General Applications Tube and Wire

Flange Style 25

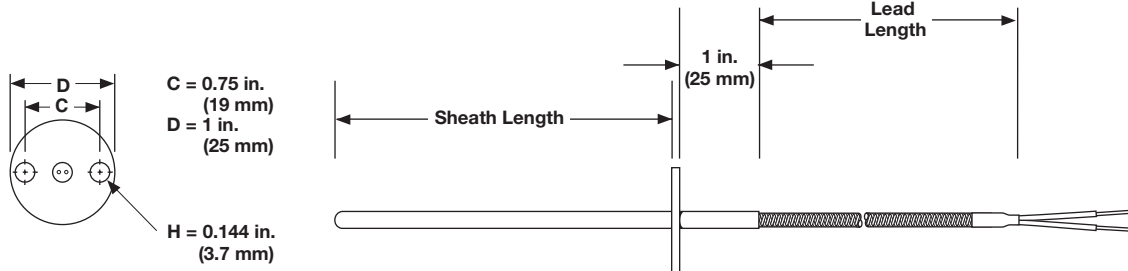

The flanged thermocouple allows rapid assembly and low profile when going through bulkheads.

Ordering Information

Part Number

1	2	3	4	5	6	7	8	9	10	11
Const. Style	Sheath Diameter	Calibration	Lead Protection	Junction	Sheath Length	Lead Length	Lead Length		Term./Options	
25										

1	2	Construction Style
25		Thermocouple with flange

3	Sheath Diameter (in.) 300 Series SS
C =	1/8 in.
D =	3/16 in.
T =	3/16 in. epoxy sealed 300°F (149°C)

4	Calibration
J =	Type J
K =	Type K
T =	Type T
E =	Type E

5	Lead Protection
F =	Fiberglass (24 gauge stranded)
S =	Fiberglass with stainless steel overbraid (24 gauge stranded)
H =	Fiberglass with stainless steel hose (24 gauge stranded)
P* =	Fiberglass (20 gauge stranded)
B* =	Fiberglass with stainless steel overbraid (20 gauge stranded)
T =	PFA (24 gauge stranded)
U =	PFA with stainless steel overbraid (24 gauge stranded)
K =	PFA with stainless steel hose (24 gauge stranded)
V* =	PFA (20 gauge stranded)
W* =	PFA with stainless steel overbraid (20 gauge stranded)

* Not available with 1/8 in. diameter sheath.

6	Junction
F =	Grounded, flat tip
G =	Grounded, round tip
D =	Grounded, drill point
R =	Ungrounded, flat tip
U =	Ungrounded, round tip
P =	Ungrounded, drill point
E =	Exposed

* Not available with 1/8 in. diameter sheath.

7	Sheath Length (in.)				
D =	2 in.	L =	5 1/2 in.	T =	9 in.
E =	2 1/2 in.	M =	6 in.	U =	9 1/2 in.
F =	3 in.	N =	6 1/2 in.	W =	10 in.
G =	3 1/2 in.	P =	7 in.	Y =	11 in.
H =	4 in.	Q =	7 1/2 in.	Z =	12 in.
J =	4 1/2 in.	R =	8 in.		
K =	5 in.	S =	8 1/2 in.		

8	9	10	Lead Length (in.)
Available lengths: 006 to 360 in., over 360 in. contact factory			

11	Termination/Options
A =	Standard, 2 1/2 in. split leads
B =	2 1/2 in. split leads with #6 spade lugs
C =	2 1/2 in. split leads with #6 spade lugs and BX connector
D =	Standard male plug, quick disconnect
E =	Standard female jack, quick disconnect
F =	Miniature male plug, quick disconnect
G =	Miniature female jack, quick disconnect
H =	1/4 in. push-on connector

General Applications Tube and Wire

Rigid Sheath Styles 30, 31 and 32

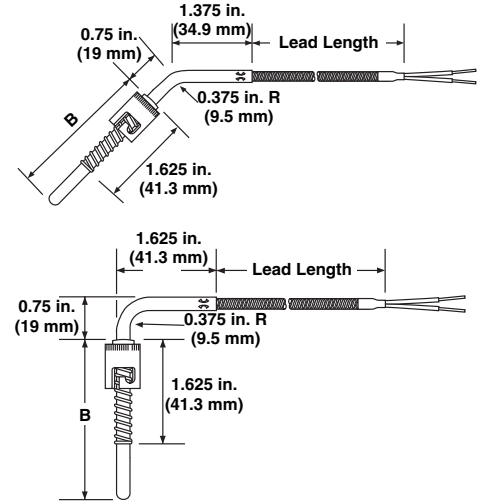
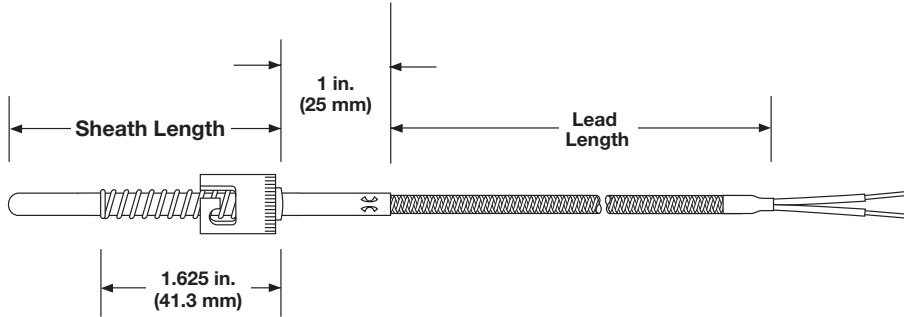

Bayonet fittings allow rapid attachment. Spring pressure on the junction tip assures fast response time.

Ordering Information

Part Number

1	2	3	4	5	6	7	8	9	10	11
Const. Style	Sheath Diameter	Calibration	Lead Protection	Junction	Sheath Length	Lead Length	Lead Length		Term./Options	

This style of bayonet fitting connects quickly and allows leads to exit with a protective sheath.

1 2 Construction Style	
30 =	7/16 in. I.D. single slot (standard cap) straight
31 =	7/16 in. I.D. single slot (standard cap) with spring, 45° bend
32 =	7/16 in. I.D. single slot (standard cap) with spring, 90° bend

3 Sheath Diameter (in.) 300 Series SS	
C =	1/8 in.
D =	3/16 in.
T =	3/16 in. epoxy sealed 300°F (149°C)

4 Calibration	
J =	Type J
K =	Type K
T =	Type T
E =	Type E

5 Lead Protection	
F =	Fiberglass (24 gauge stranded)
S =	Fiberglass with stainless steel overbraid (24 gauge stranded)
H =	Fiberglass with stainless steel hose (24 gauge stranded)
P* =	Fiberglass (20 gauge stranded)
B* =	Fiberglass with stainless steel overbraid (20 gauge stranded)
T =	PFA (24 gauge stranded)
U =	PFA with stainless steel overbraid (24 gauge stranded)
K =	PFA with stainless steel hose (24 gauge stranded)
V* =	PFA (20 gauge stranded)
W* =	PFA with stainless steel overbraid (20 gauge stranded)

* Not available with 1/8 in. diameter sheath.

6 Junction	
F =	Grounded, flat tip
G =	Grounded, round tip
D =	Grounded, drill point
R =	Ungrounded, flat tip
U =	Ungrounded, round tip
P =	Ungrounded, drill point
E =	Exposed

7 Sheath Length (in.)		
D =	2 in.	L = 5 1/2 in.
E =	2 1/2 in.	M = 6 in.
F =	3 in.	N = 6 1/2 in.
G =	3 1/2 in.	P = 7 in.
H =	4 in.	Q = 7 1/2 in.
J =	4 1/2 in.	R = 8 in.
K =	5 in.	S = 8 1/2 in.
T =	9 in.	U = 9 1/2 in.
		W = 10 in.
		Y = 11 in.
		Z = 12 in.

8 9 10 Lead Length (in.)	
Available lengths: 006 to 360 in., over 360 in. contact factory	

11 Termination/Options	
A =	Standard, 2 1/2 in. split leads
B =	2 1/2 in. split leads with #6 spade lugs
C =	2 1/2 in. split leads with #6 spade lugs and BX connector
D =	Standard male plug, quick disconnect
E =	Standard female jack, quick disconnect
F =	Miniature male plug, quick disconnect
G =	Miniature female jack, quick disconnect
H =	1/4 in. push-on connector

General Applications Tube and Wire

Large Diameter Rigid Sheath Styles 40, 41 and 42

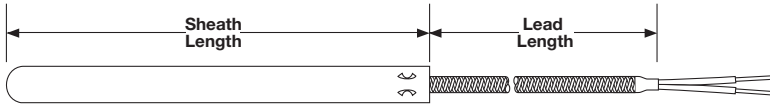

The rigid sheath provides protection and accurate placement through bulkheads or platens. Use with a compression fitting for water tight immersion application.

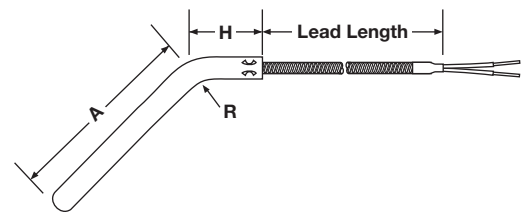

The bent rigid tube offers protection and accurate lead placement around machinery.

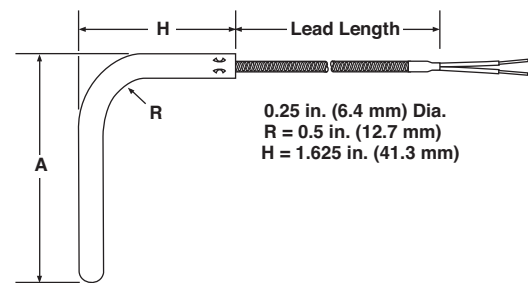

Ordering Information

Part Number

1 2	3	4	5	6	7	8 9 10	11
Const. Style	Sheath Diameter	Calibration	Lead Protection	Junction	Sheath Length	Lead Length	Term./Options

1 2	Construction Style
40 =	Plain sheath, straight, large, diameter
41 =	Plain (45°) large diameter
42 =	Plain (90°) large diameter

3	Sheath Diameter (in.) 300 Series SS
E =	1/4 in.
U =	1/4 in. epoxy sealed 300°F (149°C)

4	Calibration
J =	Type J
K =	Type K
T =	Type T
E =	Type E

5	Lead Protection
F =	Fiberglass (24 gauge stranded)
S =	Fiberglass with stainless steel overbraid (24 gauge stranded)
H =	Fiberglass with stainless steel hose (24 gauge stranded)
P =	Fiberglass (20 gauge stranded)
B =	Fiberglass with stainless steel overbraid (20 gauge stranded)
T =	PFA (24 gauge stranded)
U =	PFA with stainless steel overbraid (24 gauge stranded)
K =	PFA with stainless steel hose (24 gauge stranded)
V =	PFA (20 gauge stranded)
W =	PFA with stainless steel overbraid (20 gauge stranded)

6	Junction
F =	Grounded, flat tip
G =	Grounded, round tip
R =	Ungrounded, flat tip
U =	Ungrounded, round tip
E =	Exposed

7	Sheath Length (in.)				
A =	1 in.	J =	9 in.	S =	17 in.
B =	2 in.	K =	10 in.	T =	18 in.
C =	3 in.	L =	11 in.	U =	19 in.
D =	4 in.	M =	12 in.	W =	20 in.
E =	5 in.	N =	13 in.	Y =	22 in.
F =	6 in.	P =	14 in.	Z =	24 in.
G =	7 in.	Q =	15 in.		
H =	8 in.	R =	16 in.		

8 9 10	Lead Length (in.)
Available lengths: 006 to 360 in., over 360 in. contact factory	

11	Termination/Options
A =	Standard, 2 1/2 in. split leads
B =	2 1/2 in. split leads with #6 spade lugs
C =	2 1/2 in. split leads with #6 spade lugs and BX connector
D =	Standard male plug, quick disconnect
E =	Standard female jack, quick disconnect
F =	Miniature male plug, quick disconnect
G =	Miniature female jack, quick disconnect
H =	1/4 in. push-on connector



General Applications Tube and Wire

Flexible Extensions Style 60

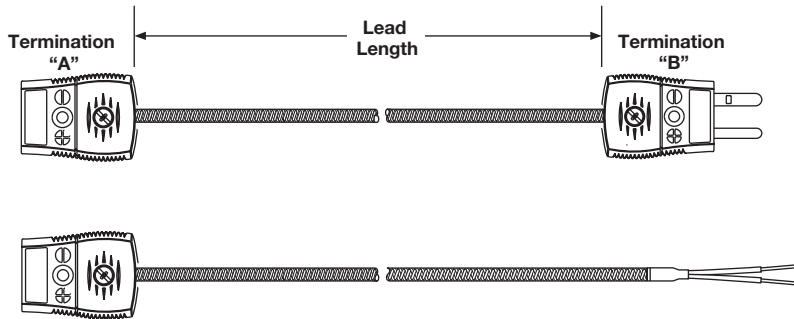

Flexible extensions allow thermocouples to be disconnected from a system without disturbing the remaining wiring.

Ordering Information

Part Number

1	2	3	4	5	6	7	8	9	10	11
Const. Style	Diameter	Calibration	Lead Protection	Junction	Term. "A"/Options	Lead Length	Lead Length		Term. B/Options	
60	X			X						

1	2	Construction Style
60		Flexible extension

3	Diameter
X	Not applicable

4	Calibration
J	Type J
K	Type K
T	Type T
E	Type E

5	Lead Protection
F	Fiberglass (24 gauge stranded)
S	Fiberglass with stainless steel overbraid (24 gauge stranded)
H	Fiberglass with stainless steel hose (24 gauge stranded)
P	Fiberglass (20 gauge stranded)
B	Fiberglass with stainless steel overbraid (20 gauge stranded)
T	PFA (24 gauge stranded)
U	PFA with stainless steel overbraid (24 gauge stranded)
K	PFA with stainless steel hose (24 gauge stranded)
V	PFA (20 gauge stranded)
W	PFA with stainless steel overbraid (20 gauge stranded)

6	Junction
X	Not applicable

7	Termination "A"/Options
A	Standard, 2 ¹ / ₂ in. split leads
B	2 ¹ / ₂ in. split leads with spade lugs
C	2 ¹ / ₂ in. split leads with spade lugs and BX connector
D	Standard male plug, quick disconnect
E	Standard female jack, quick disconnect
F*	Miniature male plug, quick disconnect
G*	Miniature female jack, quick disconnect
H	1/4 in. push-on connector
*Not available with SS hose.	

8	9	10	Lead Length (in.)
Available lengths: 006 to 360 in., over 360 in. contact factory			

11	Termination "B"/Options
A	Standard, 2 ¹ / ₂ in. split leads
B	2 ¹ / ₂ in. split leads with #6 spade lugs
C	2 ¹ / ₂ in. split leads with #6 spade lugs and BX connector
D	Standard male plug, quick disconnect
E	Standard female jack, quick disconnect
F	Miniature male plug, quick disconnect
G	Miniature female jack, quick disconnect
H	1/4 in. push-on connector



General Applications Tube and Wire

Insulated Wire Styles 61 and 62



Constructed with SERV-RITE insulated thermocouple wire, Styles 61 and 62, are economical and versatile and can be ordered with an exposed or protected measuring junction. Style 61 is fitted with an exposed junction and is suitable for most general purpose applications, such as measuring

air, gas and surface temperatures. Style 62 is fitted with an encapsulated measuring junction that is ideal for corrosive fluids and gases, such as sulfuric acid, hydrofluoric acid, strong mineral acids and oils.

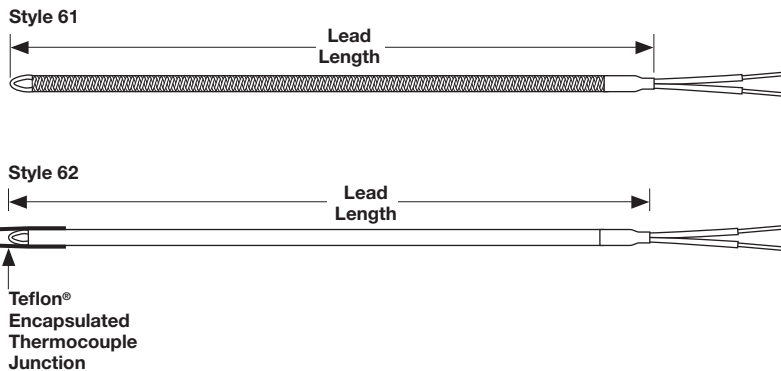

Ordering Information

Part Number

1	2	3	4	5	6	7	8	9	10	11
Const. Style	Diameter	Calibration	Lead Protection	Junction	Termination "A"	Lead Length	Term./ Options			
	X			E	X					

1	2	Construction Style
61	=	SERIES 61
62*	=	SERIES 62
*Only available with wire (lead protection) options J or T (4th digit).		

3	Diameter
X	= Not applicable

4	Calibration
J	= Type J
K	= Type K
T	= Type T
E	= Type E

5	Lead Protection
P	= Fiberglass (20 gauge solid)
B	= Fiberglass with stainless steel overbraid (20 gauge solid)
F	= Fiberglass (24 gauge solid)
S	= Fiberglass with stainless steel overbraid (24 gauge solid)
T	= Extruded PFA (24 gauge solid)
J	= Extruded PFA (20 gauge solid)

6	Junction
E	= Exposed

8	9	10	Lead Length (in.)
Available lengths: 006 to 360 in., over 360 in. contact factory			

11	Termination/Options
A	= Standard, 2 ¹ / ₂ in. split leads
B	= 2 ¹ / ₂ in. split leads with spade lugs
C	= 2 ¹ / ₂ in. split leads with #6 spade lugs and BX connector
D	= Standard male plug, quick disconnect
E	= Standard female jack, quick disconnect
F	= Miniature male plug, quick disconnect
G	= Miniature female jack, quick disconnect
H	= 1/4 in. push-on connector



General Applications Tube and Wire

Perfluoroalkoxy (PFA) Encapsulated Style 65

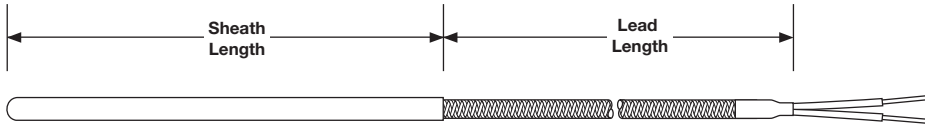

The rigid sheath is covered with a 0.010 in. (0.25 mm) wall of PFA for corrosion resistance in acid environments. An epoxy seal improves moisture resistance of the sensor and provides a barrier for migrating fumes in corrosive applications.

Ordering Information

Part Number

1	2	3	4	5	6	7	8	9	10	11
Const. Style	Diameter Under Covering	Calibration	Lead Protection	Junction	Sheath Length	Lead Length	Lead Length			Term./Options
65										

1	2	Construction Style
65		PFA coated sheath

3	Diameter (in.) Under Covering
D =	3/16 in. epoxy sealed 300°F (149°C)
E =	1/4 in. epoxy sealed 300°F (149°C)

4	Calibration
J =	Type J
K =	Type K
T =	Type T
E =	Type E

5	Lead Protection
T =	PFA (24 gauge stranded)
V =	PFA (20 gauge stranded)

6	Junction
U =	Ungrounded, round tip
G =	Grounded, round tip

7	Sheath Length (in.)				
B =	1 in.	J =	4 1/2 in.	R =	8 in.
C =	1 1/2 in.	K =	5 in.	S =	8 1/2 in.
D =	2 in.	L =	5 1/2 in.	T =	9 in.
E =	2 1/2 in.	M =	6 in.	U =	9 1/2 in.
F =	3 in.	N =	6 1/2 in.	W =	10 in.
G =	3 1/2 in.	P =	7 in.	Y =	11 in.
H =	4 in.	Q =	7 1/2 in.	Z =	12 in.

8	9	10	Lead Length (in.)
Available lengths: 006 to 360 in., over 360 in. contact factory			

11	Termination/Options
A =	Standard, 2 1/2 in. split leads
B =	2 1/2 in. split leads with #6 spade lugs
C =	2 1/2 in. split leads with #6 spade lugs and BX connector
D =	Standard male plug, quick disconnect
E =	Standard female jack, quick disconnect
F =	Miniature male plug, quick disconnect
G =	Miniature female jack, quick disconnect
H =	1/4 in. push-on connector



General Applications Tube and Wire

Ring Terminal Style 70



The nickel terminal can be placed beneath existing screws or bolts to permit surface temperature measurement.

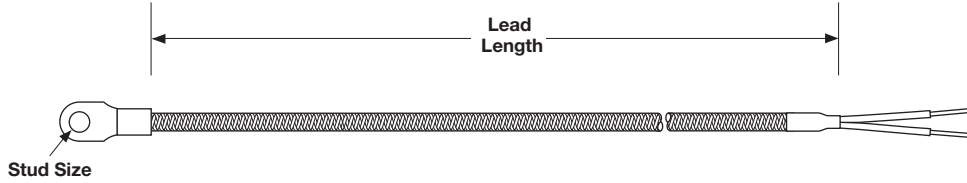

Note: Grounded junction shown.

Ordering Information

Part Number

1 2	3	4	5	6	7	8 9 10	11
Const. Style	Diameter	Calibration	Lead Protection	Junction	Stud Size Hole Diameter	Lead Length	Term./Options
70	X						

1 2	Construction Style
70	Ring terminal thermocouple

3	Diameter
X	Not applicable

4	Calibration
J	Type J
K	Type K
T	Type T
E	Type E

5	Lead Protection
F	Fiberglass (24 gauge stranded)
S	Fiberglass with stainless steel overbraid (24 gauge stranded)
P	Fiberglass (20 gauge stranded)
B	Fiberglass with stainless steel overbraid (20 gauge stranded)
T	PFA (24 gauge stranded)
U	PFA with stainless steel overbraid (24 gauge stranded)
V	PFA (20 gauge stranded)
W	PFA with stainless steel overbraid (20 gauge stranded)

6	Junction
G	Grounded
U*	Ungrounded
*Only available with 24 gauge wire.	

7	Stud Size - Hole Diameter (in.)
A*	No. 6
B*	No. 8
C*	No. 10
D	1/4
E	3/8
*Only available with 24 gauge wire.	

8 9 10	Lead Length (in.)
Available lengths: 006 to 360 in., over 360 in. contact factory	

11	Termination/Options
A	Standard, 2 1/2 in. split leads
B	2 1/2 in. split leads with #6 spade lugs
C	2 1/2 in. split leads with #6 spade lugs and BX connector
D	Standard male plug, quick disconnect
E	Standard female jack, quick disconnect
F	Miniature male plug, quick disconnect
G	Miniature female jack, quick disconnect
H	1/4 in. push-on connector



Thermocouples

General Applications Tube and Wire

Nozzle Style 71

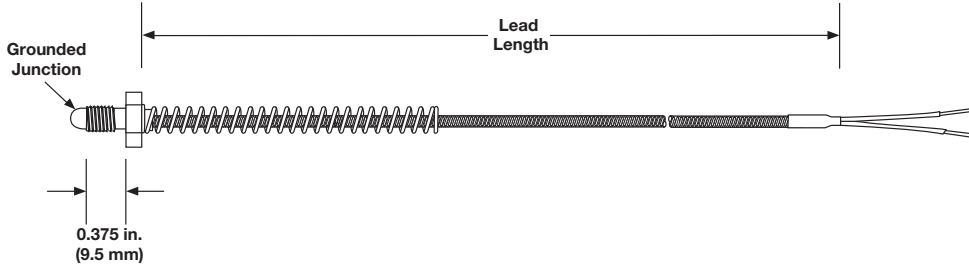

The nozzle thermocouple has a short installation depth and a low profile to allow control of thin platen sections.

Ordering Information

Part Number

1	2	3	4	5	6	7	8	9	10	11
Const. Style		Diameter Calibration		Lead Protection	Junction	304 SS Bolt Size	Lead Length			Term./Options
71		X			G					

1	2	Construction Style
71		Nozzle thermocouple

3	Diameter
X	Not applicable

4	Calibration
J	Type J
K	Type K
T	Type T
E	Type E

5	Lead Protection
F	Fiberglass (24 gauge stranded)
S	Fiberglass with stainless steel overbraid (24 gauge stranded)
P*	Fiberglass (20 gauge stranded)
B*	Fiberglass with stainless steel overbraid (20 gauge stranded)
T	PFA (24 gauge stranded)
U	PFA with stainless steel overbraid (24 gauge stranded)
V*	PFA (20 gauge stranded)
W*	PFA with stainless steel overbraid (20 gauge stranded)

*Not available with ungrounded junction.

6	Junction
G	Grounded

7	304 SS, Bolt Size
A	1/4 in. x 28 UNF, 3/8 in. thread depth
B	8-32 thread
C	10-32 thread
M	M6 x 1

8	9	10	Lead Length (in.)
			Available lengths: 006 to 360 in., over 360 in. contact factory

11	Termination/Options
A	Standard, 2 1/2 in. split leads
B	2 1/2 in. split leads with #6 spade lugs
C	2 1/2 in. split leads with #6 spade lugs and BX connector
D	Standard male plug, quick disconnect
E	Standard female jack, quick disconnect
F	Miniature male plug, quick disconnect
G	Miniature female jack, quick disconnect
H	1/4 in. push-on connector



General Applications Tube and Wire

Pipe Clamp Style 72

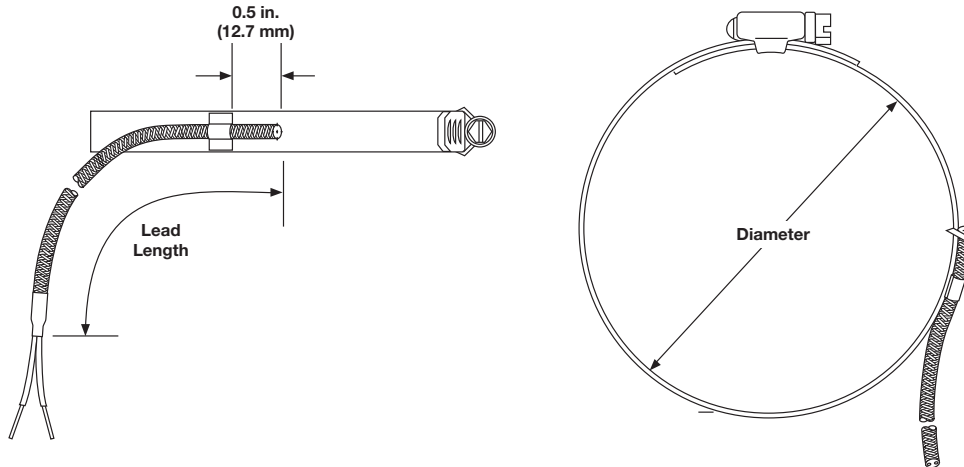

The stainless steel clamp allows temperature measurement without drilling or tapping, which is ideal for measuring pipe temperatures.

Ordering Information

Part Number

1 2	3	4	5	6	7	8 9 10	11
Const. Style	Diameter	Calibration	Lead Protection	Junction	Clamp Band Dia. Range	Lead Length	Term./Options
72	X			G			

1 2	Construction Style
72	Pipe clamp thermocouple

3	Diameter
X	Not applicable

4	Calibration
J	Type J
K	Type K
T	Type T
E	Type E

5	Lead Protection
S	Fiberglass with stainless steel overbraid (24 gauge stranded)
B	Fiberglass with stainless steel overbraid (20 gauge stranded)
U	PFA with stainless steel overbraid (24 gauge stranded)
W	PFA with stainless steel overbraid (20 gauge stranded)

6	Junction
G	Grounded

7	Clamp Band Diameter Range (in.)
A	1 ¹ / ₁₆ to 1 ¹ / ₄
B	1 ¹ / ₄ to 2 ¹ / ₄
C	2 ¹ / ₄ to 3 ¹ / ₄
D	3 ¹ / ₄ to 4 ¹ / ₄
E	4 ¹ / ₄ to 5
F	5 to 6
G	6 to 7

8 9 10	Lead Length (in.)
Available lengths: 006 to 360 in., over 360 in. contact factory	

11	Termination/Options
A	Standard, 2 ¹ / ₂ in. split leads
B	2 ¹ / ₂ in. split leads with #6 spade lugs
C	2 ¹ / ₂ in. split leads with #6 spade lugs and BX connector
D	Standard male plug, quick disconnect
E	Standard female jack, quick disconnect
F	Miniature male plug, quick disconnect
G	Miniature female jack, quick disconnect
H	1/4 in. push-on connector



Thermocouples

General Applications Tube and Wire

Grommet Style 73

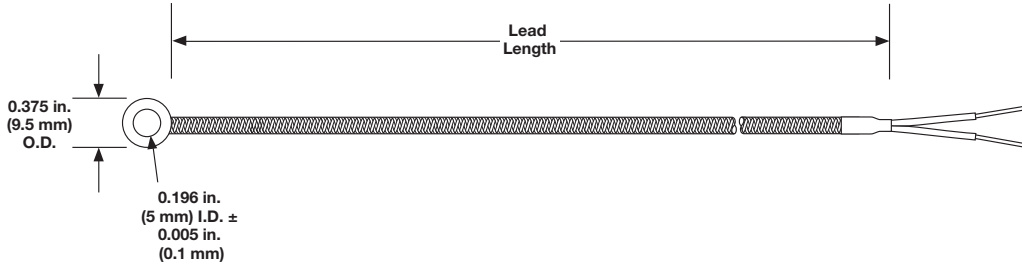

The extremely low profile of the stainless steel grommet provides fast response time.

Ordering Information

Part Number

1 2	3	4	5	6	7	8 9 10	11
Const. Style	Diameter	Calibration	Lead Protection	Junction	Grommet Size	Lead Length	Term./Options
73	X			G	A		

1 2	Construction Style
73 =	Grommet thermocouple

3	Diameter
X =	Not applicable

4	Calibration
J =	Type J
K =	Type K
T =	Type T
E =	Type E

5	Lead Protection
F =	Fiberglass (24 gauge solid)
T =	PFA (24 gauge solid)

6	Junction
G =	Grounded

7	Grommet Size (in.)
A =	0.195 in. I.D. x 0.375 in. O.D. x 0.035 in. thick

8 9 10	Lead Length (in.)
Available lengths: 006 to 360 in., over 360 in. contact factory	

11	Termination/Options
A =	Standard, 2 1/2 in. split leads
B =	2 1/2 in. split leads with #6 spade lugs
C =	2 1/2 in. split leads with #6 spade lugs and BX connector
D =	Standard male plug, quick disconnect
E =	Standard female jack, quick disconnect
F =	Miniature male plug, quick disconnect
G =	Miniature female jack, quick disconnect
H =	1/4 in. push-on connector



General Applications Tube and Wire

Brass Shim Style 74

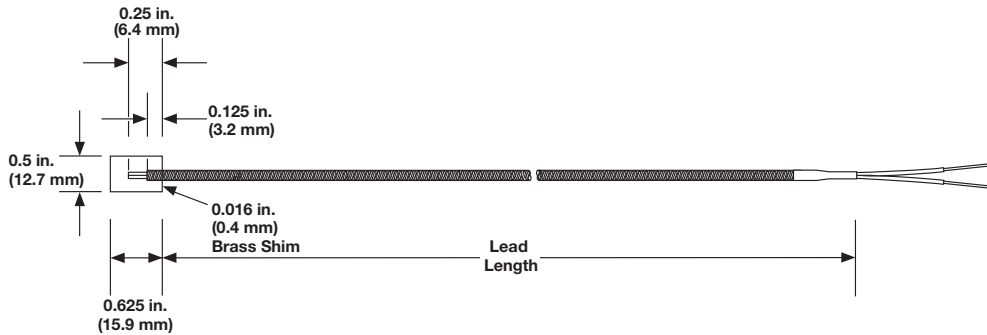

The shim stock thermocouple has a low profile and can be placed between components for surface temperature measurement.

Ordering Information

Part Number

① ②	③	④	⑤	⑥	⑦	⑧ ⑨ ⑩	⑪
Const. Style	Diameter	Calibration	Lead Protection	Junction	Shim Size	Lead Length	Term./ Options
74	X			G	A		

① ②	Construction Style
74 =	Shim stock thermocouple

③	Diameter
X =	Not applicable

④	Calibration
J =	Type J
K =	Type K
T =	Type T
E =	Type E

⑤	Lead Protection
F =	Fiberglass (24 gauge solid)
T =	PFA (24 gauge solid)

⑥	Junction
G =	Grounded

⑦	Shim Size (in.)
A =	1/2 x 5/8 x 0.016 in. brass

⑧ ⑨ ⑩	Lead Length (in.)
	Available lengths: 006 to 360 in., over 360 in. contact factory

⑪	Termination/Options
A =	Standard, 2 1/2 in. split leads
B =	2 1/2 in. split leads with #6 spade lugs
C =	2 1/2 in. split leads with #6 spade lugs and BX connector
D =	Standard male plug, quick disconnect
E =	Standard female jack, quick disconnect
F =	Miniature male plug, quick disconnect
G =	Miniature female jack, quick disconnect
H =	1/4 in. push-on connector



General Applications Tube and Wire

Stainless Steel Shim Style 75

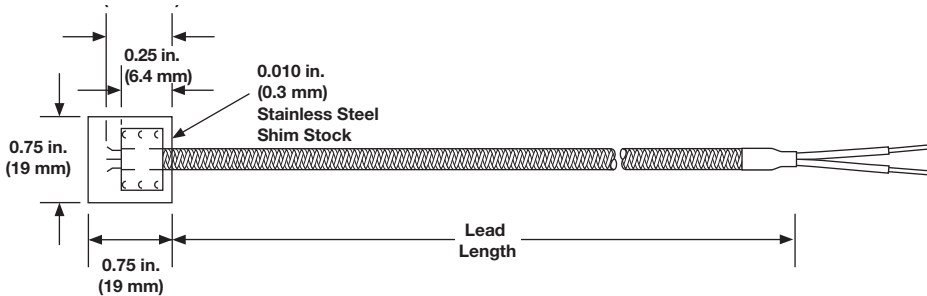

The shim stock thermocouple has a low profile and can be placed between components for surface temperature measurement.

Ordering Information

Part Number

1 2	3 4	5	6	7	8 9 10	11
Const. Style	Diameter Calibration	Lead Protection	Junction	Shim Size	Lead Length	Term./Options
75	X		G	A		

1 2	Construction Style
75	Stainless steel shim stock thermocouple

3	Diameter
X	Not applicable

4	Calibration
J	Type J
K	Type K

5	Lead Protection
F	Fiberglass (24 gauge stranded)
S	Fiberglass with stainless steel overbraid (24 gauge stranded)
T	PFA (24 gauge stranded)
U	PFA with stainless steel overbraid (24 gauge stranded)

6	Junction
G	Grounded

7	Shim Size (in.)
A	$\frac{3}{4} \times \frac{3}{4} \times 0.010$ in., 430 SS

8 9 10	Lead Length (in.)
Available lengths: 006 to 360 in., over 360 in. contact factory	

11	Termination/Options
A	Standard, 2 $\frac{1}{2}$ in. split leads
B	2 $\frac{1}{2}$ in. split leads with #6 spade lugs
C	2 $\frac{1}{2}$ in. split leads with #6 spade lugs and BX connector
D	Standard male plug, quick disconnect
E	Standard female jack, quick disconnect
F	Miniature male plug, quick disconnect
G	Miniature female jack, quick disconnect
H	$\frac{1}{4}$ in. push-on connector

General Applications Tube and Wire

Polyimide Bracket Style

The polyimide thermocouple, when used with the aluminum bracket, is designed primarily to measure roller temperature. Light pressure on the roller enables the polyimide thermocouple to measure roller surface temperature without using slip rings. This type of set-up greatly reduces lag time and eliminates slip rings cost and maintenance. It can also be used to measure conveyor belt temperatures and any other moving part by riding gently on the part surface.

- Continuous use at 400°F (200°C), 500°F (260°C) for limited periods
- Low mass
- Fast response
- Totally insulated construction
- Available in Type J or K

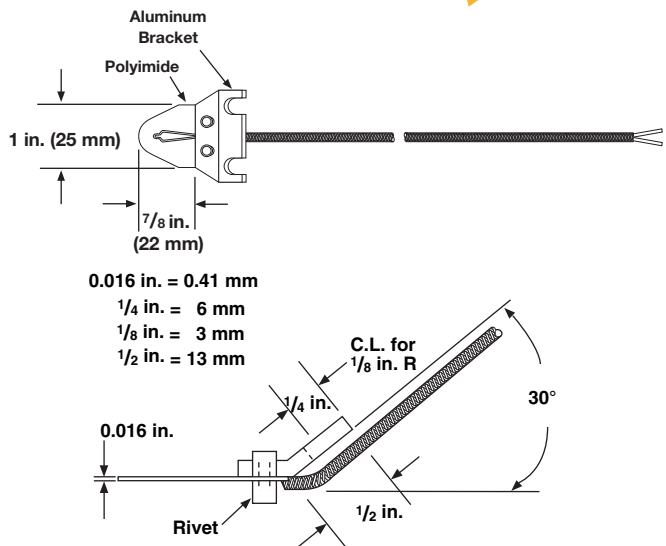

Polyimide Thermocouple with Bracket

Calibration	Lead Length in. (cm)	Part No.
J	48 (122)	OKJ30B4A
	96 (244)	OKJ30B4B
K	48 (122)	OKK30B2A
	96 (244)	OKK30B2B

Sensors with 30 gauge solid thermocouple wire, with fiberglass insulation and split lead termination.

Low Profile Polyimide Peel and Stick Style



Low Profile Polyimide Thermocouple (without Bracket)

When used without the bracket it can be placed between heated parts for accurate temperature measurement. At the thermocouple junction, the overall thickness is only 0.016 in. (0.4 mm), so that it does not interfere with fit or thermo conductivity.

Calibration	Lead Length in. (cm)	Part No.
J	48 (122)	OKJ30B2A
	96 (244)	OKJ30B2B
K	48 (122)	OKK30B1A
	96 (244)	OKK30B1B

Sensors with 30 gauge solid thermocouple wire, with fiberglass insulation and split lead termination.

Polyimide Peel and Stick

This sensor requires no bracket or special mounting. Simply peel away the backing and this self-adhesive film will bond to almost any surface. Temperature ratings for continuous use is 400°F (200°C).

Calibration	Lead Length in. (cm)	Part No.
J	48 (122)	OKJ30B11A
	96 (244)	OKJ30B11B
K	48 (122)	OKK30B10A
	96 (244)	OKK30B10B
T	48 (122)	OKT30B12A
	96 (244)	OKT30B12B

Sensors with 30 gauge solid thermocouple wire, with fiberglass insulation and split lead termination.



Thermocouples

Mineral Insulated (MI)

Watlow's mineral insulated (MI) thermocouples are fast-responding, durable and capable of handling high temperatures.

Manufactured with best-in-class XACTPAK®, Watlow's trademark for metal sheathed, mineral insulated (MI) thermocouple material, XACTPAK responds fast because the protective metal outer sheath allows use of smaller diameter thermocouple conductors. The rock hard compacted MgO insulation further enhances the sensor's ability to "read" temperature by transferring heat quickly to the measuring junction.

The XACTPAK protecting sheath and compacted insulation outperform bare wire thermocouples in most applications.

Performance Capabilities

- Easily handles temperatures up to 2200°F (1200°C)
- Meets or exceeds initial calibration tolerances per ASTM E 230

Features and Benefits

Special mineral insulation

- Protects thermocouple from moisture and thermal shock
- Permits operation in high temperature, high pressure environments

Diameters as small as 0.020 in. (0.50 mm)

- Ideal when physical space or extremely fast response are critical

Flexibility of the XACTPAK material

- Allows forming and bending of the thermocouple, without risk of cracking, to meet design requirements

Outer sheath

- Protects wires from oxidation and hostile environments

Wide range of sheath materials, diameters and calibrations

- Meet specific requirements

In-house manufacturing of XACTPAK material

- Rigid quality control procedures
- Ensures high standards are met
- Single source reliability

Custom capabilities

- Include options such as special lead lengths, lead wires and terminations



Typical Applications

- Heat treating
- Furnaces/kilns
- Turbines
- Bearing temperature
- Power stations
- Steam generators
- Diesel engines
- Nuclear reactors
- Atomic research
- Jet engines and test cells
- Rocket engines
- Semiconductor manufacturing
- Refineries/oil processing
- Catalytic reformers
- Food processing

Mineral Insulated

Bends

Diameter in.	Standard Bend Radius in.	Minimum "H" Dimension in.	Minimum "C" Dimension in.
0.063	3/16	1/2	1 1/2
0.090	1/4	3/4	1 1/2
0.125	3/8	1	2
0.188	1/2	1	2
0.250	3/4	2	2
0.313	1 1/4	2	2
0.375	1 1/2	3	2
0.500	2	4	2

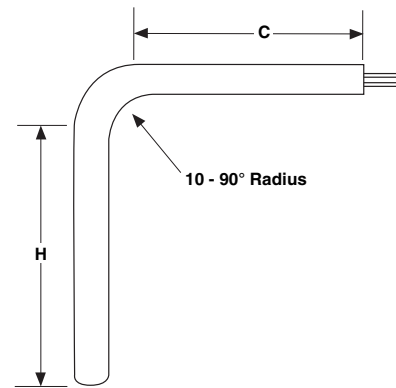

Lead Terminations

Termination	Code	Length
<p>Standard Male Plug</p>	A	—
<p>Standard Female Jack</p>	B	—
<p>Standard Male Plug with Mating Connector</p>	C	—
<p>Miniature Male Plug</p>	F	—
<p>Miniature Female Jack</p>	G	—
<p>Miniature Male Plug with Mating Connector</p>	H	—
<p>Split Leads</p>	T	1 1/2
<p>#8 Spade Lugs</p>	U	1 1/2



Mineral Insulated

Fitting Options Fixed Fittings

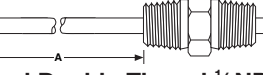
Fitting Type	Material	Sheath Size in.	NPT Thread Size in.	Hex Size in.	Length in.	Code
 Fixed Single Thread 1/8 NPT Customer Specified	303 SS	0.063 to 0.250	1/8	7/16	11/16	A
 Fixed Single Thread 1/4 NPT Customer Specified	303 SS	0.125 to 0.250	1/4	9/16	7/8	B
 Fixed Single Thread 1/2 NPT Customer Specified	303 SS	0.125 to 0.250	1/2	7/8	1	D
 Fixed Double Thread 1/2 NPT Customer Specified	303 SS	0.125 to 0.250	1/2	7/8	1 3/4	F

Compression Fittings

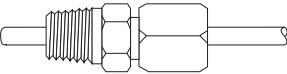
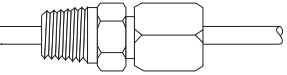
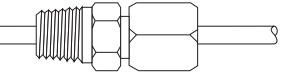
Fitting Type	Material	Sheath Size in.	NPT Thread Size in.	Hex Size in.	Length in.	Code
 Non-Adjustable Compression Brass	Brass	0.125	1/8	1/2	1	J
		0.188	1/8	1/2	1 1/8	J
		0.250	1/8	1/2	1 3/16	J
 Non-Adjustable Compression SS	303 SS	0.063	1/8	1/2	1 1/4	L
		0.125	1/8	1/2	1 1/4	L
		0.188	1/8	1/2	1 5/16	L
		0.250	1/8	1/2	1 5/16	L
 Adjustable Compression TFE Gland	303 SS	0.063	1/8	1/2	1 1/4	G
		0.125	1/8	1/2	1 1/4	G
		0.188	1/8	1/2	1 1/4	G
		0.250	1/4	7/8	2 7/16	X
 Adjustable Compression Lava Gland	303 SS	0.063	1/8	1/2	1 1/4	Q
		0.125	1/8	1/2	1 1/4	Q
		0.188	1/8	1/2	1 1/4	Q
		0.250	1/4	7/8	2 7/16	V

Compression Fittings: Compression fittings are shipped finger-tight on the sheath allowing field installation. Once non-adjustable fittings are deformed, they cannot be relocated. Adjustable fittings come with tetrafluorethylene (TFE) sealant or lava sealant glands.

Mineral Insulated

Fitting Options (Continued)

Adjustable Spring Loaded

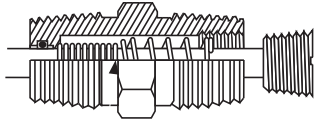
Fitting Type	Material	Sheath Size in.	NPT Thread Size in.	Hex Size in.	Length in.	Code
	316 SS	0.250	1/2	7/8	2	H

Bayonet Lockcap and Spring

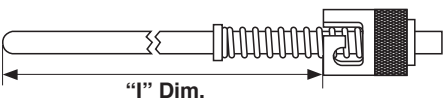
Fitting Type	Material	Sheath Size in.	Length in.	Code
	Plated Steel	0.125	1 ⁵ / ₈	W
	Plated Steel	0.188	1 ⁵ / ₈	W
	Plated Steel	0.063	1 ⁵ / ₈	W

Weld Pads

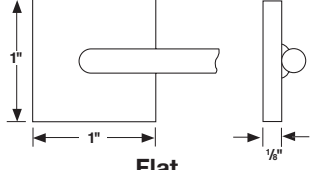
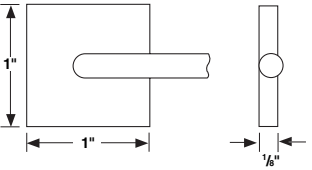
Weld Pad Type	Material	Code
 Flat	304 SS*	2
 Milled Slot	304 SS	5

*Alloy 600 available on special order and recommended for use with alloy 600 sheath.



Mineral Insulated

Cut and Stripped Style AB

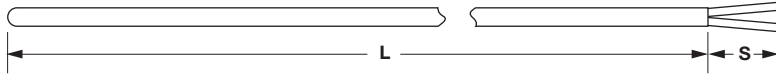

Watlow's Style AB thermocouple allows self termination of the thermocouple. Style AB is simply a section of XACTPAK material, junctioned and stripped and is the most basic of all the mineral insulated thermocouple styles.

Its XACTPAK mineral insulation construction protects the thermocouple from moisture, thermal shock, high temperatures and high pressure.

Performance Capabilities

- Maximum temperature depends on sheath material, calibration and other variables

Features and Benefits

Cold end stripped and sealed with epoxy

- Inhibits moisture penetration

Dual element style

- Allows two instruments to run from the same element, reducing costs

Ordering Information

Part Number

1	2	3	4	5	6	7	8 9	10	11	12	13	14	15
A	B	Sheath O.D.	Special Options	Fittings, Weld Pads		Sheath Material	Sheath Length "L" (whole in.)	Sheath Length "L" (fract. in.)	Junction	Calibration	Strip Length "S" (whole in.)	Strip Length "S" (fract. in.)	
A	B				0								0

3 Sheath O.D. (in.)	
B =	0.020
C =	0.032
D =	0.040
E =	0.063
G =	0.125
H =	0.188
J =	0.250

4 Special Options	
0 =	No spring loaded and extension leads
1 =	Extension leads only
2 =	Spring loading hardware with extension leads

5 Fittings, Weld Pads	
0 =	None
Notes: If required, enter code from pages 47 to 48. If none, enter "0." Weld pads only available for 0.063 in. diameter and larger.	

7 Sheath Material	
A =	304/304L SS
C =	304/304L SS with Teflon® encapsulation
E =	316/316L SS with Teflon® encapsulation
F =	316/316L SS
Q =	Alloy 600 (Type K)

8 9 Sheath Length "L" (whole in.)	
Available lengths: 01 to 99, for lengths over 99 inches contact factory	

10 Sheath Length (fractional in.)	
0 =	0
4 =	1/2

11 Junction			
	Grounded	Ungrounded	Exposed
Single	G	U	E
Dual*	H	W (isolated)	D (isolated)

*Only available for 0.063 diameter in alloy 600.

12 Calibration				
	E	J	K	T
Standard limits	E	J	K	T
Special limits	2	3	4	8

13 Strip Length "S" (whole in.)	
0, 1, 2 and 3 - 1 in. max. on 0.040 and smaller	

14 Strip Length "S" (fractional in.)	
0 =	0
1 =	1/8
2 =	1/4
3 =	3/8
4 =	1/2
5 =	5/8
6 =	3/4
7 =	7/8



Mineral Insulated

Mini Plug or Jack Termination Style AC

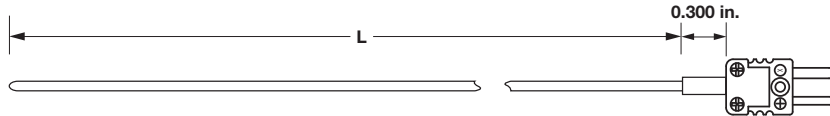

Ordering Information

Part Number

①	②	③	④	⑤	⑥	⑦	⑧ ⑨	⑩	⑪	⑫	⑬ ⑭	⑮
A	C	Sheath O.D.	Connector Type	Fittings, Weld Pads	0	Sheath Material	Sheath Length "L" (whole in.)	Sheath Length "L" (fract. in.)	Junction	Calibration	00	0
A	C				0						00	0

③ Sheath O.D. (in.)	
B =	0.020
C =	0.032
D =	0.040
E =	0.063
G =	0.125

④ Connector Type	
F =	Miniature plug
G =	Miniature jack
H =	Miniature plug with mating connector
Note: Miniature plugs and jacks 400°F (200°C) (0.125 in. max. O.D.).	

⑤ Fittings, Weld Pads	
0 =	None
Notes: If required, enter code from pages 47 to 48. If none, enter "0." Weld pads only available for 0.063 in. and 0.125 in. diameters.	

⑦ Sheath Material	
A =	304/304L SS
C =	PFA coated over 304/304L SS (available on G diameter)
E =	316/316L SS with Teflon® encapsulation
F =	316/316L SS
Q =	Alloy 600 (Type K)

⑧ ⑨ Sheath Length "L" (whole in.)	
Available lengths: 01 to 99, for lengths over 99 inches contact factory. Maximum length for PFA coating is 48 in.	

⑩ Sheath Length "L" (fractional in.)	
0 =	0
4 =	1/2

⑪ Junction			
	Grounded	Ungrounded	Exposed
Single	G	U	E

⑫ Calibration				
	E	J	K	T
Standard limits	E	J	K	T
Special limits	2	3	4	8



Thermocouples

Mineral Insulated

Standard Plug or Jack Termination Style AC

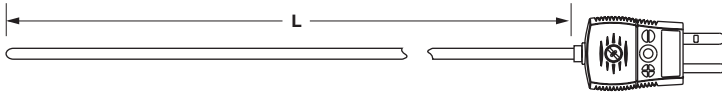

Ordering Information

Part Number

1	2	3	4	5	6	7	8	9	10	11	12	13	14	15
	Sheath O.D.		Connector Type	Fittings, Weld Pads		Sheath Material	Sheath Length "L" (whole in.)		Sheath Length "L" (fract. in.)	Junction	Calibration			
A	C				0							00		0

3 Sheath O.D. (in.)	
D =	0.040
E =	0.063
G =	0.125
H =	0.188
J =	0.250

4 Connector Type	
A =	Standard plug
B =	Standard jack
C =	Standard plug with mating connector
Note: Standard plug and jacks 425°F (218°C).	

5 Fittings, Weld Pads	
0 =	None
Notes: Standard plug and jacks 425°F (218°C). Weld pads only available for 0.063 in. diameter and larger.	

7 Sheath Material	
A =	304/304L SS
F =	316/316L SS
C =	PFA coated over 304/304L SS (available on G, H, J diameters)
E =	316/316L SS with Teflon® encapsulation
Q =	Alloy 600 (Type K)

8 9 Sheath Length "L" (whole in.)	
Available lengths: 01 to 99, for lengths over 99 inches contact factory. Maximum length for PFA coating is 48 in.	

10 Sheath Length "L" (fractional in.)	
0 =	0
4 =	1/2

11 Junction			
	Grounded	Ungrounded	Exposed
Single	G	U	E
Dual*	H	W (isolated)	D (isolated)
* Only available for 0.063 in. diameter and larger.			

12 Calibration				
	E	J	K	T
Standard limits	E	J	K	T
Special limits	2	3	4	8



Mineral Insulated

Metal Transitions with Spring Strain Relief Style AF

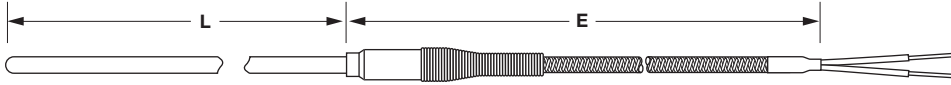

Ordering Information

Part Number

①	②	③	④	⑤	⑥	⑦	⑧ ⑨	⑩	⑪	⑫	⑬ ⑭	⑮
	Style	Sheath O.D.	Lead Wire Const.	Fittings, Weld Pads	Lead Wire Term.	Sheath Material	Sheath Length "L" (whole in.)	Sheath Length "L" (fract. in.)	Junction	Calibration	Lead Wire Length "E" (whole ft)	Special Rqmts.
A	F											

② Style	
F =	Metal transition with strain relief and 300°F (149°C)

③ Sheath O.D. (in.)	
B =	0.020
C =	0.032
D =	0.040
E =	0.063
G =	0.125
H =	0.188
J =	0.250

④ Lead Wire Construction				
		Standard	Overbraid	Flex Armor
Fiberglass	Solid	A	J	R
FEP	Solid	C	L	T
Fiberglass	Stranded*	B	K	S
FEP	Stranded*	D	M	U

*Stranded lead wire available only for sheath O.D. 0.063 in. and larger.

⑤ Fittings, Weld Pads	
0 =	None

Notes: If required, enter code from pages 47 to 48. If none, enter "0."
Weld pads available for 0.063 in. and larger.

⑥ Lead Wire Termination	
A =	Standard male plug
B =	Standard female jack
C =	Standard plug with mating connector
F =	Miniature male plug
G =	Miniature female jack
H =	Miniature plug with mating connector
T =	Standard, 1 1/2 in. split leads
U =	1 1/2 in. split leads with #8 spade lugs

⑦ Sheath Material	
A =	304/304L SS
F =	316/316L SS
C =	PFA coated over 304/304L SS (available on G, H and J diameter)
E =	316/316L SS with Teflon® encapsulation
Q =	Alloy 600 (Type K)

⑧ ⑨ Sheath Length "L" (whole in.)	
Available lengths: 01 to 99, for lengths over 99 inches contact factory. Maximum length for PFA coating is 48 in.	

⑩ Sheath Length "L" (fractional in.)	
0 =	0
4 =	1/2

⑪ Junction			
	Grounded	Ungrounded	Exposed
Single	G	U	E
Dual*	H	W (isolated)	D (isolated)

*Only available for 0.063 in. diameter and larger.

⑫ Calibration				
	E	J	K	T
Standard limits	E	J	K	T
Special limits	2	3	4	8

⑬ ⑭ Lead Wire Length "E" (whole feet)	
Available lengths: 01 to 30, for lengths over 30 contact factory	

⑮ Special Requirements	
0 =	Standard 300°F (149°C)
H =	High temperature 1000°F (538°C) potting
M =	500°F (260°C)



Thermocouples

Mineral Insulated

Miniature Transitions Style AQ

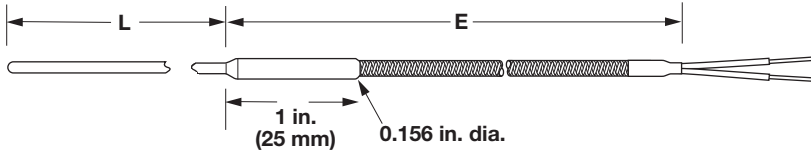

Note: 300°F (149°C) potting standard

Ordering Information

Part Number

①	②	③	④	⑤	⑥	⑦	⑧ ⑨	⑩	⑪	⑫	⑬ ⑭	⑮
	Style	Sheath O.D.	Lead Wire Const.		Lead Wire Term.	Sheath Material	Sheath Length "L" (whole in.)	Sheath Length "L" (fract. in.)	Junction	Calibration	Lead Wire Length "E" (whole ft)	Special Rqmts.
A	Q			0								

②	Style
Q =	Miniature metal transition with 300°F (149°C)

③	Sheath O.D. (in.)
B =	0.020
C =	0.032
D =	0.040
E =	0.063

④	Lead Wire Construction
A =	Fiberglass solid - 30 gauge
B =	Fiberglass solid - 24 gauge
C =	FEP solid - 30 gauge
D =	FEP solid - 24 gauge

⑥	Lead Wire Termination
A =	Standard male plug
B =	Standard female jack
C =	Standard plug with mating connector
F =	Miniature male plug
G =	Miniature female jack
H =	Miniature plug with mating connector
T =	Standard, 1 1/2 in. split leads
U =	1 1/2 in. split leads with #8 spade lugs

⑦	Sheath Material
A =	304/304L SS
F =	316/316L SS
Q =	Alloy 600 (Type K)

⑧ ⑨	Sheath Length "L" (whole in.)
Available lengths: 01 to 99, for lengths over 99 inches contact factory	

⑩	Sheath Length "L" (fractional in.)
0 =	0
4 =	1/2

⑪	Junction		
	Grounded	Ungrounded	Exposed
Single	G	U	E

⑫	Calibration	
Standard limits	J	K
Special limits	3	4

⑬ ⑭	Lead Wire Length "E" (whole feet)
Available lengths: 01 to 30	

⑮	Special Requirements
0 =	Standard 300°F (149°C)
M =	500°F (260°C) potting



Mineral Insulated

Connection Head Style AR

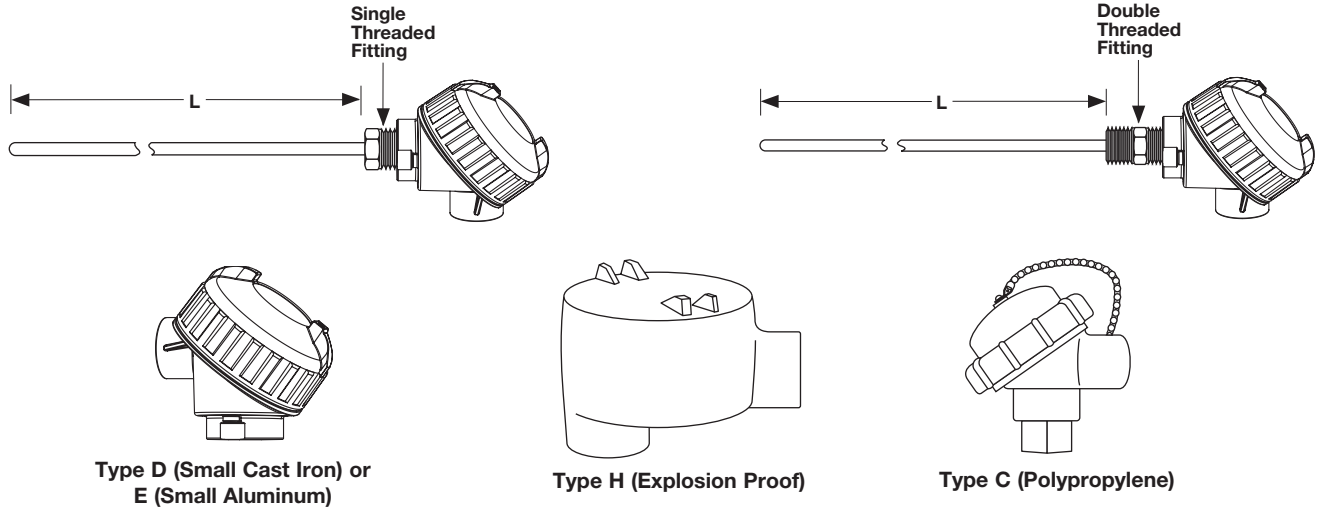

Ordering Information

Part Number

1	2	3	4	5	6	7	8	9	10	11	12	13	14	15
		Sheath O.D. (in.)	Connection Head	Head Mounting Fittings		Sheath Material	Sheath Length "L" (whole in.)		Sheath Length "L" (fract. in.)	Junction	Calibration			
A	R				0							00		0

3 Sheath O.D. (in.)	
G =	0.125
H =	0.188
J =	0.250

4 Connection Head	
C =	Polypropylene
D =	Small cast iron
E =	Small aluminum
H =	Explosion proof
U =	E head with 5750 transmitter*
V =	C head with 5750 transmitter*
W =	H head with 5750 transmitter*
* For units with a transmitter, the order must specify a temperature range and °F or °C.	

5 Head Mounting Fittings	
0 =	Single threaded 303 SS
F =	Double threaded 303 SS 1/2 in. NPT
H* =	Spring loaded double threaded 316 SS 1/2 in. NPT
*0.250 in. diameter only	

7 Sheath Material	
A =	304/304L SS
F =	316/316L SS
Q =	Alloy 600 (Type K)

8 9 Sheath Length "L" (whole in.)	
Available lengths: 01 to 99, for lengths over 99 inches contact factory	

10 Sheath Length "L" (fractional in.)	
0 =	0
1 =	1/8
2 =	1/4
3 =	3/8
4 =	1/2
5 =	5/8
6 =	3/4
7 =	7/8

11 Junction			
	Grounded	Ungrounded	Exposed
Single	G	U	E
Dual	H	W (isolated)	D (isolated)

12 Calibration				
	E	J	K	T
Standard limits	E	J	K	T
Special limits	2	3	4	8



Thermocouples

Mineral Insulated

For Use With Thermowells
Style AT

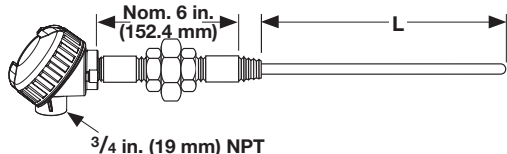

Type 1 - 6 inch N-U-N typical (2 each 1/2 x 3 inch steel pipe nipples and 1 each malleable union)

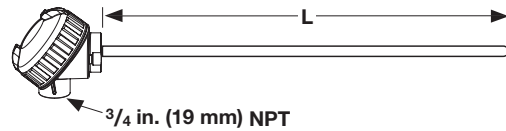

Type 4 - Connection Head Only with 1/2 inch NPT process connection

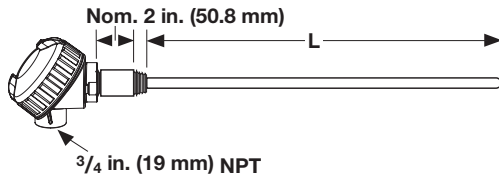

Type 3 - 1/2 x 3 inch steel pipe nipple typical

Ordering Information

Part Number

1	2	3	4	5	6	7	8	9	10	11	12	13	14	15
		Sheath O.D. (in.)	Connection Head	Cold End Config.		Sheath Material	Sheath Length "L" (whole in.)	Sheath Length "L" (fract. in.)		Junction	Calibration		Spring-Loading	
A	T	J			0							0		0

3	Sheath O.D. (in.)
J =	0.250

4	Connection Head
C =	Polypropylene (1/2 in. NPT thermocouple opening only)
D =	Small cast iron
E =	Small aluminum
H =	Explosion proof (1/2 in. NPT and 3/4 in. NPT thermocouple opening only)

5	Cold End Configuration
1 =	Type 1, 6 in. nipple-union-nipple
3 =	Type 3, 3 in. nipple
4 =	Type 4, no extensions
Note: Steel nipple and unions are standard.	

7	Sheath Material
A =	304/304L SS
F =	316/316L SS
Q =	Alloy 600 (Type K)

8	9	Sheath Length "L" (whole in.)
Available lengths: 01 to 99, for lengths over 99 inches contact factory		

10	Sheath Length "L" (fractional in.)
0 =	0
1 =	1/8
2 =	1/4
3 =	3/8
4 =	1/2
5 =	5/8
6 =	3/4
7 =	7/8

11	Junction	
	Grounded	Ungrounded
Single	G	U
Dual	H	W (isolated)

12	Calibration			
	E	J	K	T
Standard limits	E	J	K	T
Special limits	2	3	4	8

14	Spring-Loading
Y =	Yes
N =	No

Note: For a complete sensor, add thermowell part number to the 15-digit AT part number. For sheath length, use "AR" (as required) and the factory will determine correct length.



EXACTSENSE®

The EXACTSENSE® thermocouple from Watlow provides the accuracy, time response and durability required to help manufacturers improve the control of their diesel engine aftertreatment systems. The resulting benefits include more efficient regeneration, better fuel economy and improved emissions to meet the more stringent global requirements.

The EXACTSENSE thermocouple features integrated electronics within a molded connector housing. The electronics convert the thermocouple signal into either an analog or digital output signal that is compatible with the engine control module (ECM). Having a sensor with integrated electronics helps improve overall system accuracy and enables the use of information about the sensor such as part number, serial number, date of manufacture, time response, calibration, drift and more to enhance system performance or improve diagnostic capabilities.

The EXACTSENSE thermocouple includes WATCOUPLE™ sensing technology. This technology uses materials selected for their stability and longevity at high temperatures making this thermocouple an ideal choice for burner, flame and turbo applications. The durable mineral insulated thermocouple construction is also superior for applications requiring long immersion depths up to 7.9 in. (200 mm). The EXACTSENSE is point sensitive unlike RTDs, which average the temperature over the length of the element. These EXACTSENSE features provide the ability to accurately measure the temperature near the center of larger pipes without complex algorithms.

The mineral insulated construction also enables the tip to be tapered. This durable closed tip construction results in faster response times than competing sensor technologies can achieve with their less durable open tip constructions. EXACTSENSE tapered construction results in improved control and increased sensor life.

The EXACTSENSE thermocouple meets the demanding requirements for over-the-road medium and heavy-duty vehicles as well as on off-road equipment including construction, mining, agriculture, marine and locomotive. The EXACTSENSE thermocouple is available with a variety of standard options to meet specific manufacturer requirements.



Features and Benefits

Integrated electronics

- Provide high system accuracy resulting in improved fuel economy
- Enable the availability of information for system performance monitoring and improved diagnostic capability
- Allow a variety of output signals compatible with ECMs

WATCOUPLE thermocouple technology

- Provides reliability in rugged environments
- Operates at a wide range of temperatures
- Maximizes stability at high temperatures
- Provides longer sensor life

Tapered tip construction

- Provides faster response time
- Increases life of sensors due to closed tip construction

Long immersion depth

- Improves detection of actual process temperatures

Typical Applications

- Diesel particulate filter (DPF)
- Diesel oxidation catalyst (DOC)
- Selective catalytic reduction (SCR)
- Exhaust gas recirculation (EGR)
- Lean NOx trap (LNT)
- Turbocharger
- Burner
- Reformer



EXACTSENSE

Specifications

Sensor Type

- Mineral insulated thermocouple

Output Options

- Analog 0 – 5V ratiometric analog voltage signal (RAVS)
- Analog 0 – 5V non-ratiometric analog voltage signal (AVS)
- LIN 2.1 or 1.3 compatible
- CAN J1939

Analog Supply Voltage (Vs1)

- 5V ± 0.25VDC

LIN Supply Voltage (Vs2)

- 9 to 17VDC

CAN Supply Voltage

- 6 to 16VDC

LIN Output Communication Speed

- 9600, 19200 baud rate
- LIN 2.1 or 1.3 compatible

CAN Output Communication Speed

- 250,000, 500,000 baud rate

Operating Temperature Range of Sensor

- -40 to 1382°F (-40 to 750°C) (stainless)
- -40 to 1832°F (-40 to 1000°C) (alloy 600)
- -40 to 2012°F (-40 to 1100°C) (Haynes® 230)

Analog Accuracy with Electronics

- ±18°F (±10°C) from -40 to 932°F (-40 to 500°C)
- ±22.5°F (±12.5°C) from 932 to 1832°F (500 to 1000°C)

LIN Accuracy with Electronics

- ±14.4°F (±8°C) from -40 to 2012°F (-40 to 1100°C)

CAN Accuracy with Electronics

- 12.6°F (±7°C) from -40 to 1112°F (-40 to 600°C)

Response Time (T63) 0.08 in. (2.1 mm) Tip

- ~3 seconds in air moving at 70 meters/second

Response Time (T63) 0.16 in. (4.0 mm) Tip

- ~7 seconds in air moving at 70 meters/second

Immersion Depth (A Dimension)

- 0.98 to 7.87 in. (25 to 200 mm)

Operating Temperature Range of Electronics and Connector

- -40 to 248°F (-40 to 120°C)

Operating Temperature Range of Sensor to Wire Interface

- -40 to 392°F (-40 to 200°C)

Electromagnetic Interference (EMI), Radio Control Frequency (RFI)

- 100V/meter 20MHz to 2GHz

Materials and Mounting

Sheath Materials

- 316 SS, alloy 600 or Haynes® 230

Mounting Fittings

- M12x1.5-6g, M14x1.5-6g and M16x1.5-6g, 400 SS

Lead Wire

- 0.96 mm² (18 AWG - 19 strands of 30 AWG) stranded wire with Tefzel® insulation

Protective Sleeve

- 392°F (200°C) silicone coated fiberglass sleeve (optional)

Connector

- Tyco Electronics 776488-1 (AMPSEAL 16 SERIES) with 2 rows of 2 gold plated pins
- Mating connector: Tyco plug 776487-1, Tyco S&F gold plated socket 776492-1, Tyco plug seal 776363-1



EXACTSENSE

Dimensional Drawings

Bent Probe (90°)

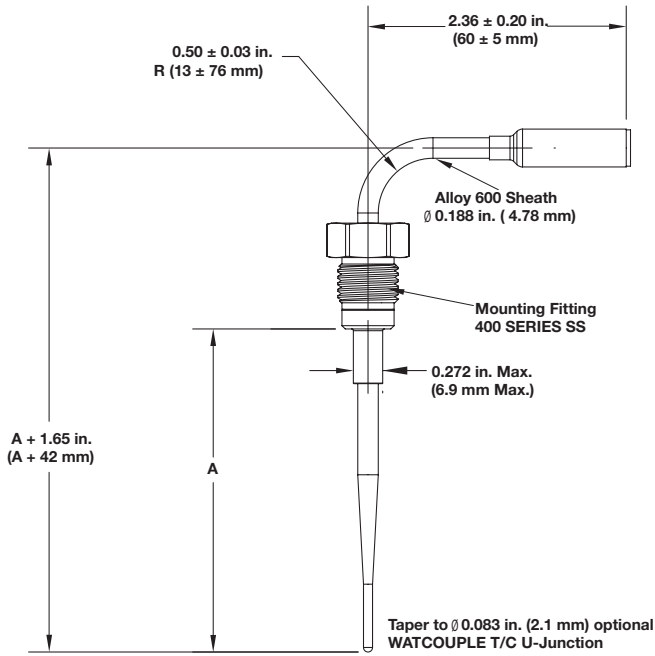

Assembly (Shown with Three Inputs)

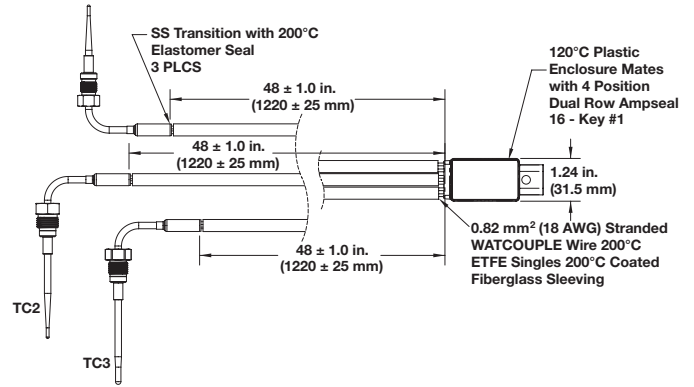

Electronic Housing

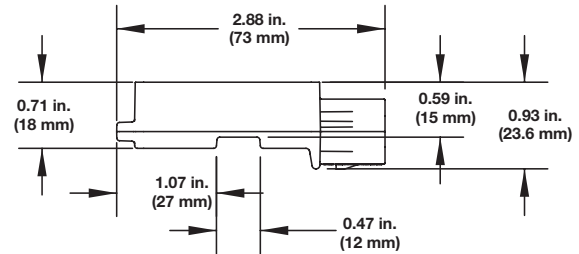

Straight Probe

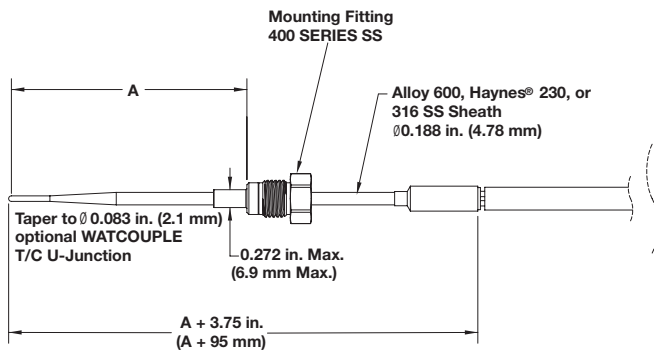



MICROCOIL™

Accurate, Repeatable, Fast Response in Perpendicular Surface Measurement

Watlow's MICROCOIL™ miniature thermocouple provides surface temperature measurements that deliver an unparalleled degree of accuracy. This patented technology achieves critical isothermal surface temperature measurement and offers superior design flexibility.

Typical sensor-to-sensor repeatability of one to 2% (DT) can be achieved with the MICROCOIL because sensor areas that are vulnerable to normal production variances are not inside of the thermal gradient. Weld location, insulation thickness and welded tip thickness no longer impact measurement in an isothermal environment. Therefore, the inherent challenges of measuring surface temperatures no longer exist.

The MICROCOIL thermocouple utilizes Watlow's XACTPAK® mineral insulated thermocouple cable. When used with an ungrounded junction, the sensor is electrically isolated from the surface being measured. For higher voltage applications, the aluminum nitride sensor disc option can be used for additional protection.

The helix design of the MICROCOIL thermocouple elicits a faster response time because the surface temperature conducts only through the diameter of the cable and the width of the sensor disk.

Thermal analysis demonstrates the superior performance of the MICROCOIL technology. This patented process achieves critical isothermal area for a long length of a very small cable, ensuring accurate and repeatable measurement.

Standard straight sensors experience poor accuracy of response time, non-repeatable results as well as errors ranging from 20 to 30 percent and higher.

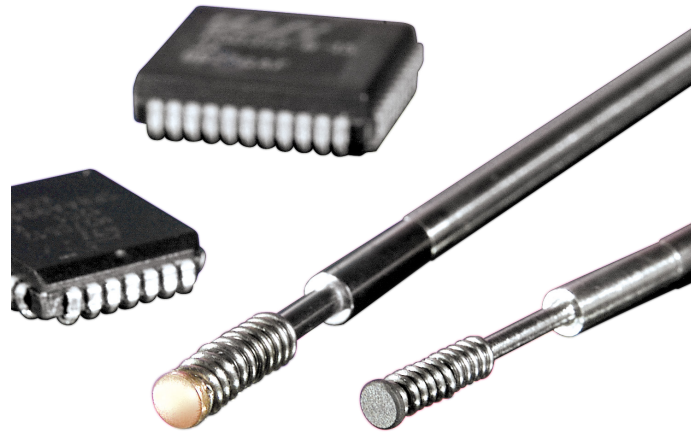

Features and Benefits

Miniature size

- Allows for precision measurement in tight spaces

XACTPAK mineral insulated thermocouple cable

- Electronically isolated and shielded 1292°F (700°C) maximum continuous temperature
- Offers exact measurement for demanding applications

Self leveling and loading

- Provides superior repeatability of measurement for a wide variety of surfaces

Typical Applications

- Environmental chambers
- Chip cases
- Heat sinks
- Packaging
- Platens



MICROCOIL

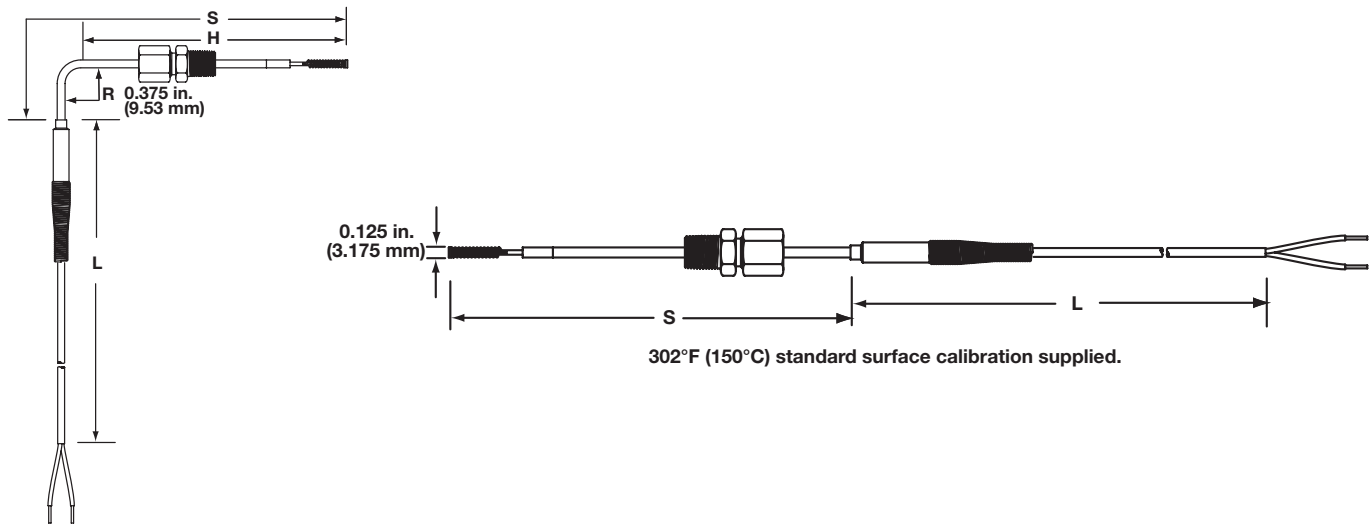

Ordering Information

Part Number

① ②	③	④	⑤ ⑥	⑦	⑧	⑨	⑩ ⑪	⑫
MC	Temp. Rating	Junction Type	Sheath Length "S"	Hot Leg Length "H"	Fitting, Optional	Lead Length Const.	Lead Length "L"	Lead Wire Term.

Type K Calibration. 0.020 inch diameter Alloy 718 thermocouple sheath, 0.125 inch coil diameter, 12.5 oz approx. spring force for 0.0500 inch compression.

③ Temperature Rating	
C =	Copper tip 662°F (350°C) max.
N =	Aluminum nitride 1292°F (700°C) max.

④ Junction Type	
G =	Grounded single junction
U =	Ungrounded single junction

⑤ ⑥ Sheath Length "S"	
XX =	02 to 18 in.

⑦ Hot Leg Length "H", if 90° bend (in.)	
0 =	N/A, straight length
H =	2.000
M =	2.500
S =	3.000

Notes: Standard bend radius is 0.375 in.
Cold leg length (1 inch min.) = S - H - 0.4 inch
If a fitting is ordered, it will be installed hand tightened onto the hot leg.
If a fitting is ordered, the min. hot leg length "H" is 2.500 in.

⑧ Fitting, Optional	
0 =	None
C =	Compression fitting, adjustable, 1/8 in. NPT, TFE gland

⑨ Lead Length Construction, Solid Conductors	
1 =	24 gauge fiberglass
2 =	26 gauge FEP with shield and drain not attached
5 =	24 gauge FEP with stainless steel overbraid

⑩ ⑪ Lead Length "L"	
XX =	06 to 99 in.

⑫ Lead Wire Terminations	
A =	Standard male plug
B =	Standard female jack
C =	Standard plug with mating connector
F =	Miniature male plug
G =	Miniature female jack
H =	Miniature plug with mating connector
T =	Standard, 1.5 in. split leads
U =	1.5 in. split leads with spade lugs

Radio Frequency

Watlow's TR thermocouple probe is designed for use in plasma generation applications to ensure accurate temperature readings through radio or conduction environments where traditional sensors are ineffective. Radio frequency energy can cause serious temperature measurement errors when exposed to these types of environments.

The TR probe is constructed using a unique combination of high performance materials. The sensor tip is made from high thermal conductivity materials to provide a quick response time. High dielectric insulation electrically insulates the sensor from capacitive coupling. Lead wires are twisted to improve common mode rejection and reduce induced EMI (electromagnetic interference).

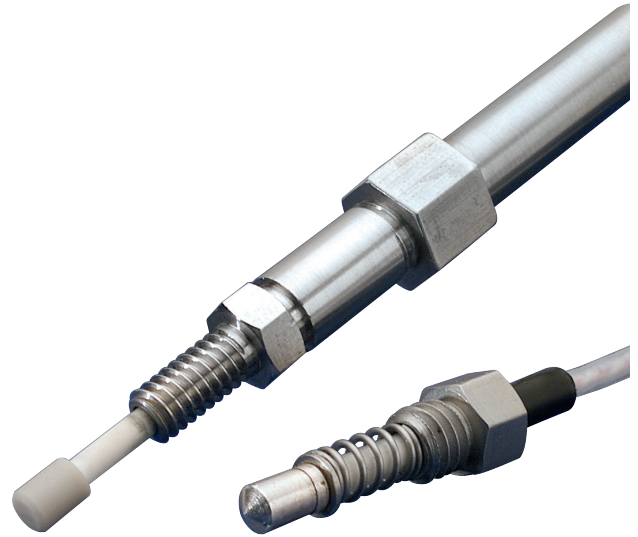

Features and Benefits

3000VDC dielectric rating

- Allows thermocouple to be used in platens with dc bias

High thermal conductivity design

- Ensures accurate, repeatable measurements

High CMMR lead wire design

- Reduces induced error from EMI

Options

- Type K calibration
- 0.875 in. (22.23 mm) to 1.5 in. (3 mm) immersion depths
- $\frac{5}{16}$ - 18 or M8 threaded fitting
- 500°F (260°C) or 932°F (500°C) rated constructions



Radio Frequency

TR Thermocouple

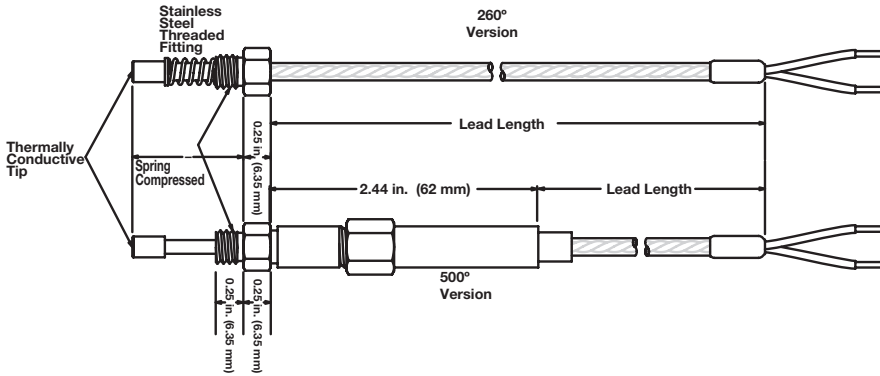

Platen Modification Detail

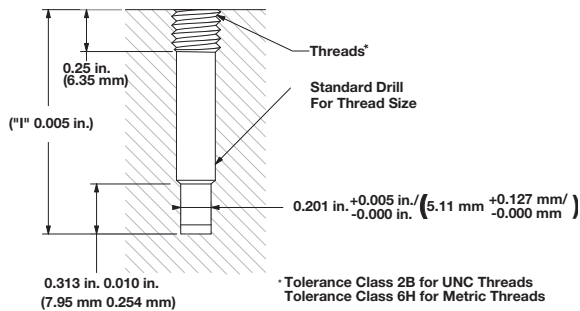

Tip Shape

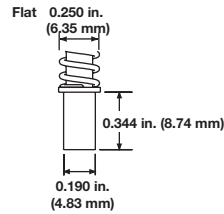

Ordering Information

Part Number

1 2	3	4	5 6	7	8	9	10 11	12
TR	Max. Temp.	Tip Shape	Imm. Depth "I"	Threaded Fitting Size	Junction Type	Calibration	Lead Length "L"	Lead Wire Term.
TR								

3	Maximum Temperature
C =	260°C silver-plated copper tip
N =	500°C aluminum nitride tip (AIN)

4	Tip Shape
F =	Flat

5 6	Immersion Depth "I" (in.)
From Tip to top of threads, spring compressed	
08 =	0.875
10 =	1.000
11 =	1.125
12 =	1.250
13 =	1.375
15 =	1.500

7	Threaded Fitting Size
5 =	$5/16$ -18 UNC-2A
8 =	M8 x 1.25-6g

8	Junction Type
U =	Ungrounded single

9	Calibration
K =	Special limits K (± 1.1 °C or ± 0.4 %)

10 11	Lead Length "L"
XX =	12 to 48 in.

12	Lead Wire Terminations
A =	Standard male plug
B =	Standard female jack
C =	Standard plug with mating connector
F =	Miniature male plug
G =	Miniature female jack
H =	Miniature plug with mating connector
T =	Standard, 1.5 in. split leads
U =	1.5 in. split leads with spade lugs



Thermocouples

TRUE SURFACE (TST)

Increase Surface Temperature Accuracy with Improved Thermocouple Design

Watlow's TRUE SURFACE thermocouple (TST) offers superior accuracy for measuring flat surface temperatures. This compact, highly accurate sensor isolates the thermocouple junction from ambient airflow. The TST typically achieves accuracy and repeatability between one to two percent (ΔT).

The TST, with its removable molded cover, fits into corners and other tight locations. TSTs are easy to install with a variety of commonly used screw types.

Watlow's TST sensor is ideal for many applications including semiconductor chambers, platens, packaging, cleaning and food preparation.

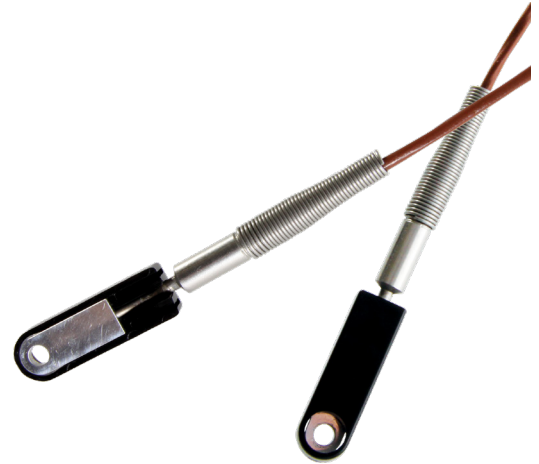

Features and Benefits

Isothermal measuring junction

- Offers excellent thermal conductivity for the measuring junction

Molded insulator

- Isolates the isothermal measuring block from ambient airflow

Compact, universal package

- Fits into corners and other tight locations easily (0.44 in. (11.88 mm) side by 0.24 in. (6.10 mm) high)
- Molded insulator is removable for applications where an even smaller package is needed

Temperature rating of 400°F (200°C)

- Offers superior application flexibility for a wide variety of surfaces

Options

- Ungrounded or grounded junction(s)
- Type J or K calibrations
- Shielded lead wire with drain, either isolated from or connected to the sensor sheath

Steady State Temperature Measurement Test

- **Purpose:** To determine and compare the steady state error of the Watlow TST and a common "washer"-style thermocouple at several temperature settings with and without ambient airflow.
- **Test Description:** Each sensor was attached to a brass hot plate and allowed to reach equilibrium before temperature readings were taken. Room temperature air was then blown onto the hot plate and the sensors. Temperature readings were taken after the system reached the new equilibrium point. The test was performed with a 20, 40, 60 and 80°C differential between the hot plate temperature and ambient.
- **Results:** Ambient temperature = 25°C.

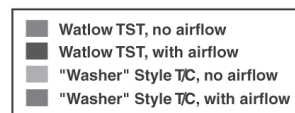
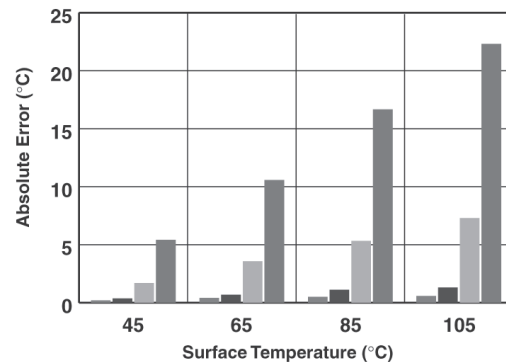



TRUE SURFACE (TST)

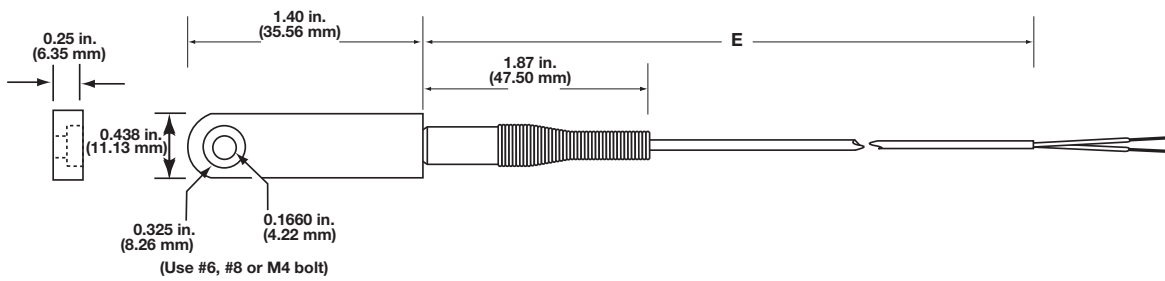

Ordering Information

Part Number

① ② ③	④ Lead Wire Const.	⑤ Lead Wire Term.	⑥ Junction Type	⑦ Calibration	⑧ ⑨ Lead Length "E"
TST					

④ Lead Wire Construction	
2 =	FEP 26 gauge solid
3 =	FEP 26 gauge solid with shield and ground, not continuous to sheath (Terminations A, B and C are not available with this lead wire construction).

⑤ Lead Wire Terminations	
A =	Standard male plug
B =	Standard female jack
C =	Standard plug with mating connector
F =	Miniature male plug
G =	Miniature female jack
H =	Miniature plug with mating connector
T =	Standard, 1.5 in. split leads
U =	1.5 in. split leads with spade lugs

⑥ Junction Type		
	Grounded	Ungrounded
Single	G	U

⑦ Calibration		
	J	K
Standard limits	J	K
Special limits	3	4

⑧ ⑨ Lead Length "E"	
01 to 99 feet	



Thermocouples

Multipoints

Temperature variances exist in all systems, regardless of materials, working fluid or system design. There is not a process that involves heating a particular medium where temperature of that medium is consistent throughout—temperature gradients always exist. Sensing temperature at a single location during a process is acceptable for many applications because temperature gradients are often insignificant. However, there is a need for many applications to monitor temperature in multiple locations to ensure a safe, accurate and cost efficient process. Installing multiple, independent temperature sensors may be impractical due to cost or space limitations.

Multipoint temperature sensors accurately measure temperatures at various locations along the sensor's length. They are used across a broad range of processes and installations—predominately in applications involving a large or complex process where close temperature control is necessary.

Multipoint temperature sensors are designed to meet requirements of specific applications that include temperature, pressure, chemical environments, time response and number of points required. Sensors are constructed from a variety of protecting tube materials that use XACTPAK mineral insulated, metal-sheathed cable. Multipoint temperature sensors are available in standard or special ASTM thermocouple calibration tolerances. For applications requiring extreme accuracy, special constructions can be made with platinum resistance temperature detectors (RTDs).



Typical Applications

- Chemical processing
- Petroleum distillation towers
- Semiconductor manufacturing
- Profiles of furnaces and kilns
- Combustion research
- Storage tanks
- Air flow ducts



Multipoints

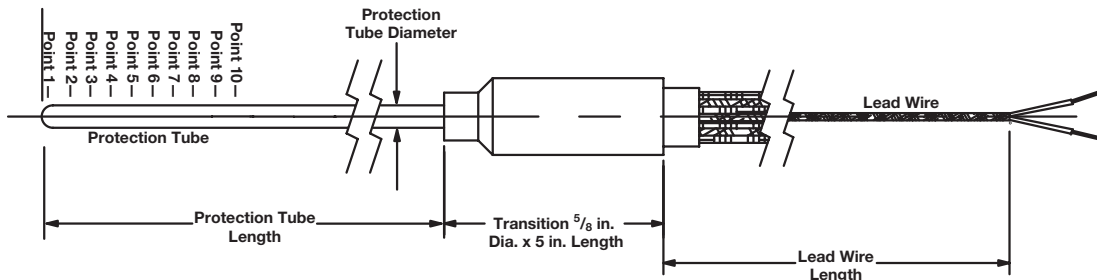

Note: Sensor point locations are measured from the protection tube tip. Please specify point location when ordering.

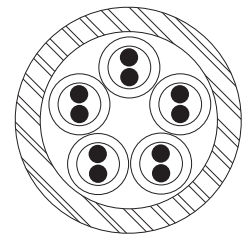

Thermocouple sensors made from mineral insulated, metal-sheathed cable are positioned inside the overall protection sheath.

Ordering Information

Part Number

①	②	③	④	⑤	⑥	⑦	⑧	⑨	⑩	⑪	⑫	⑬	⑭	⑮
AW		Prot. Tube Dia.	Number of Points		Prot. Tube Materials	Calibration	Junction	Protection Tube Length			Lead Wire Const.	Lead Wire Length		Lead Wire Term.

③ Protection Tube Diameter (in.)	
G =	0.125
H =	0.188
J =	0.250

④ ⑤ Number of Points	
	01, 02, 03, 04*, 05*, 06*, 07*, 08*, 09*, 10**

⑥ Protection Tube Materials	
F =	316 SS
Q =	Alloy 600***

⑦ Calibration		
	J	K
Standard limits	J	K
Special limits	3	4

⑧ Junction	
G =	Grounded
U =	Ungrounded

⑨ ⑩ ⑪ Protection Tube Length (in.)	
	006 to 096

⑫ Lead Wire Construction	
A =	Fiberglass solid wire
C =	FEP solid wire

⑬ ⑭ Lead Wire Length (ft)	
	01 to 25

⑮ Lead Wire Terminations	
A =	Standard male plug
B =	Standard female jack
C =	Standard plug with mating connector
F =	Miniature male plug
G =	Miniature female jack
H =	Miniature plug with mating connector
T =	Standard, 1½ in. split leads

* Not available for 0.125" option

** Not available for 0.125" or 0.188" option

*** Only available for type K selection